

# Les techniques de dessin

Les techniques de  
chiffres, de lettres et  
des figures  
géométriques

**Le chiffre deux (2) : le canard (vu de profil gauche) qui nage.**

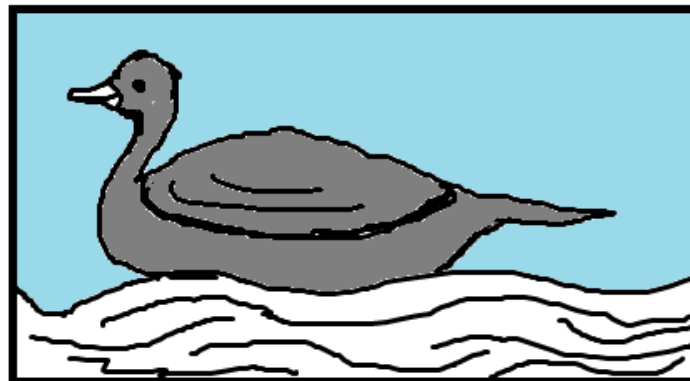

# Le chiffre six (6) : la houe

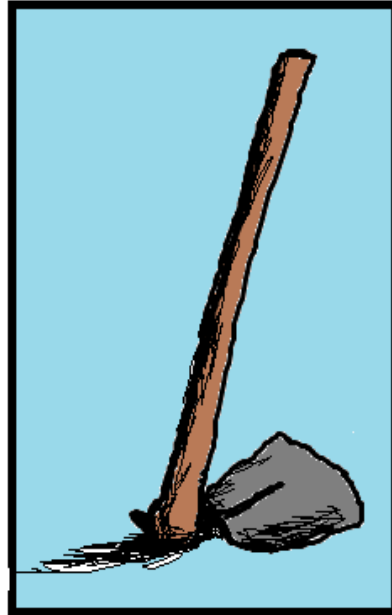
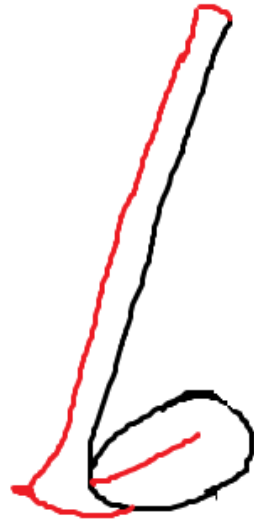

# Le chiffre six(6) : le lapin assis (profil droit)



# Le chiffre quatre (4) : le panneau

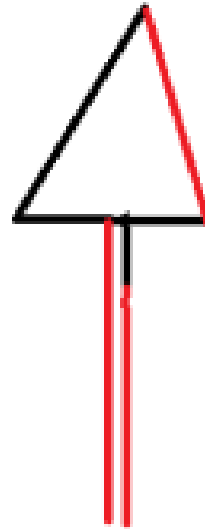
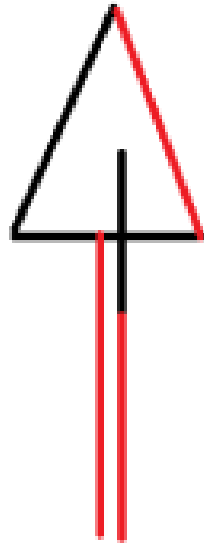
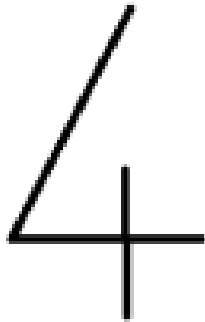

# Le chiffre sept (7) : la hache

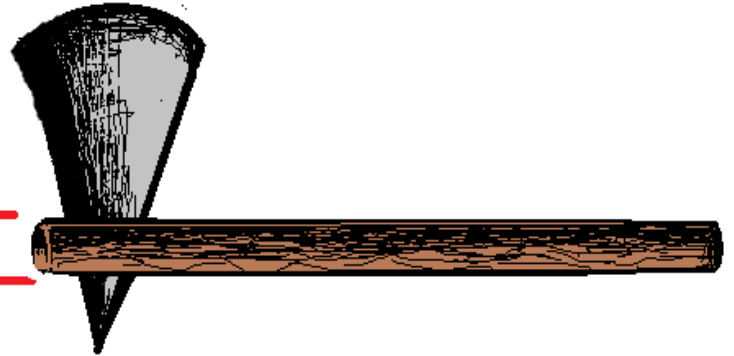
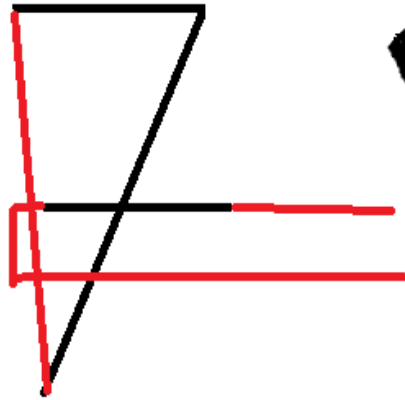
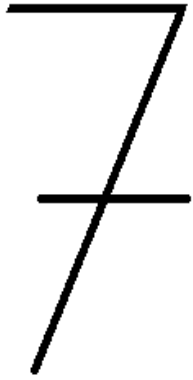

# Le chiffre huit(8) : la gourde

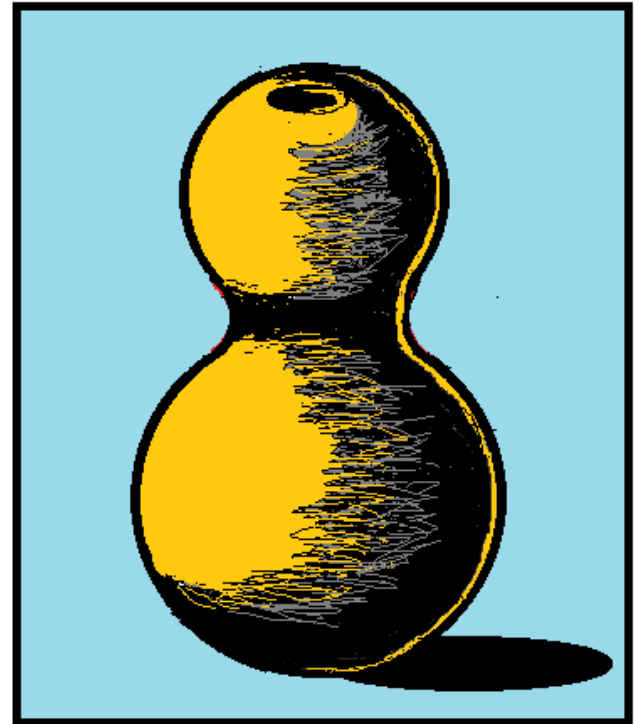
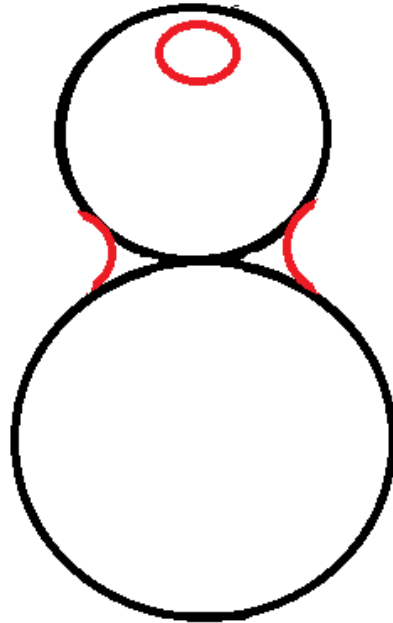
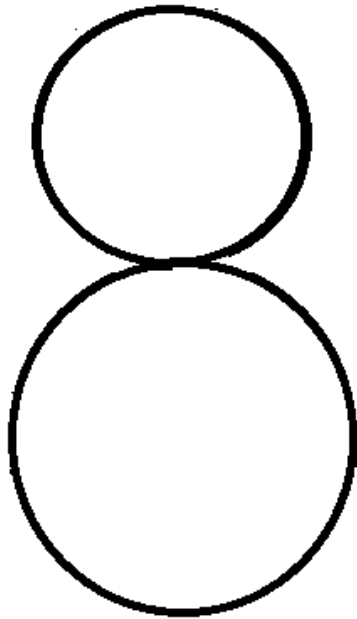

# Le chiffre neuf (9) : la mangue

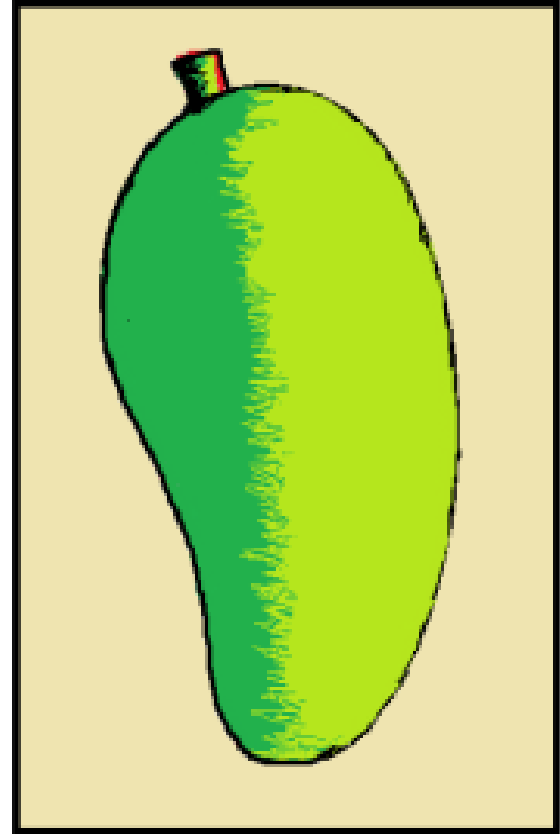
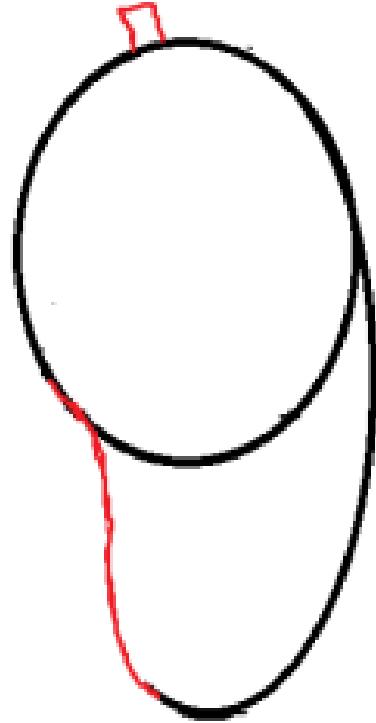
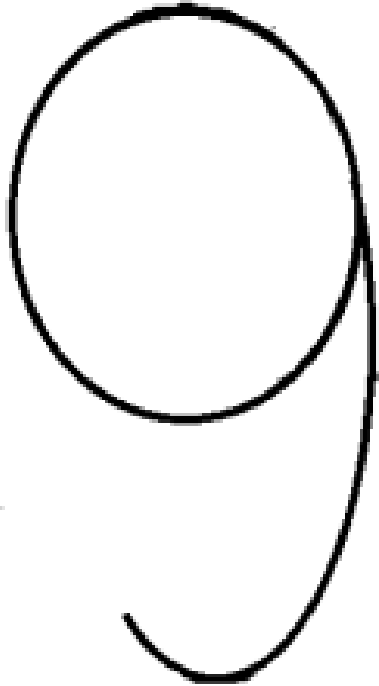

# Le chiffre neuf(9) : le gobelet

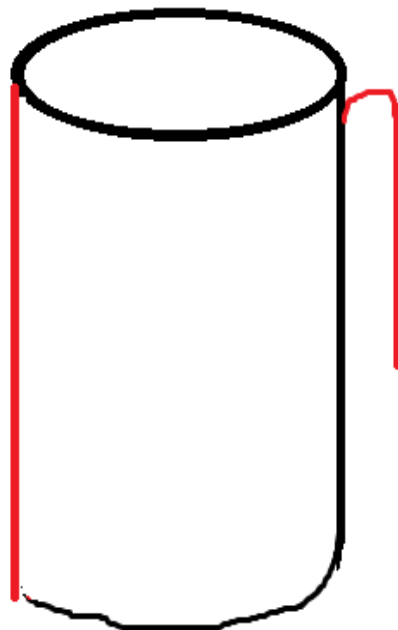
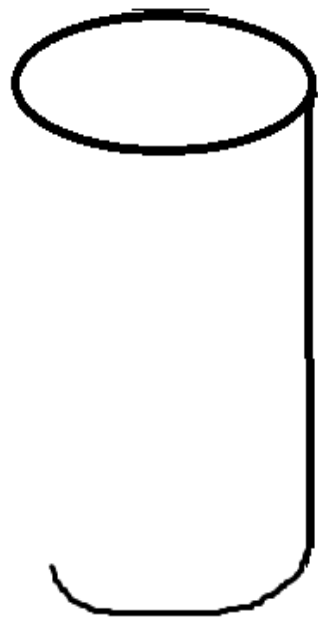

**Le point d'interrogation ( ? ), les parenthèses ( ), la lettre V , le chiffre quatre (4) et la barre : l'oiseau perché en face.**

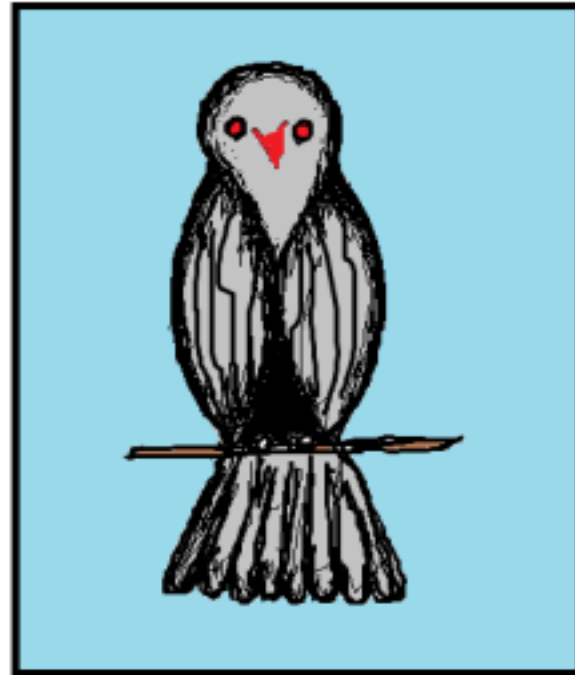
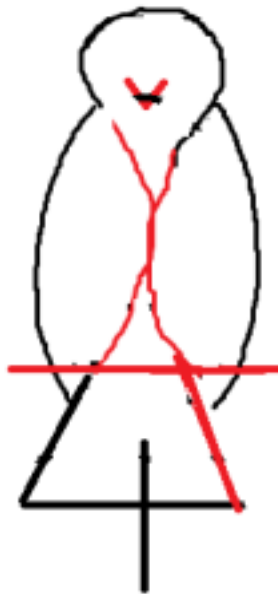

# Les lettres J,O et H : l'éléphant vu de profil gauche

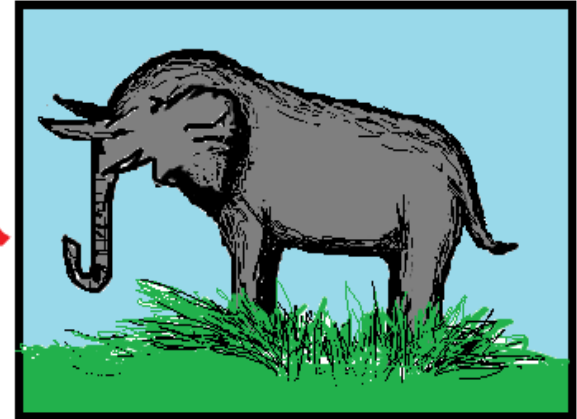
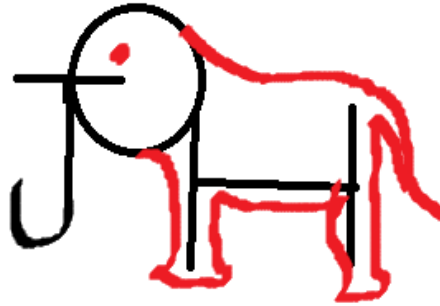
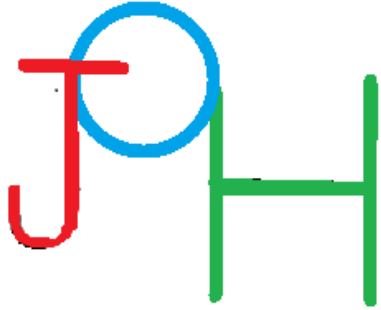

**La lettre l : l'oiseau (vu de profil droit) perché sur une branche**

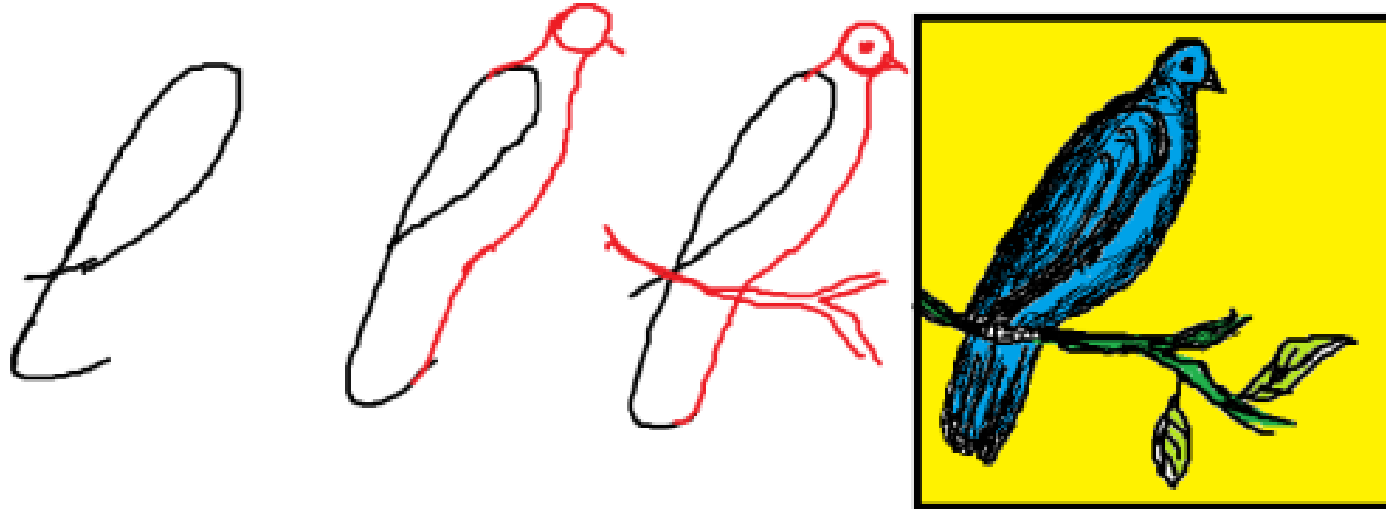

# Les lettres M<sup>2</sup>, W<sup>2</sup> et e : le porc vu de profil gauche

M<sup>2</sup>  
Σ W W<sup>2</sup> e

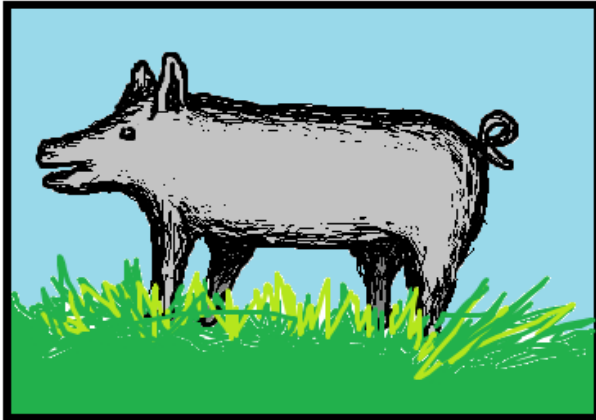
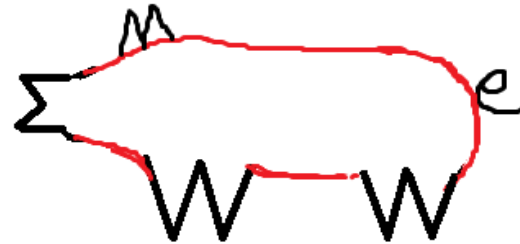

**Le point d'interrogation ( ? ), le chiffre quatre(4), le chiffre trois (3) à l'envers : le buste de l'homme vu de profil gauche**



**Le point d'interrogation ( ?), le chiffre quatre(4), le chiffre trois (3) à l'envers : le buste de la femme vu de profil gauche**

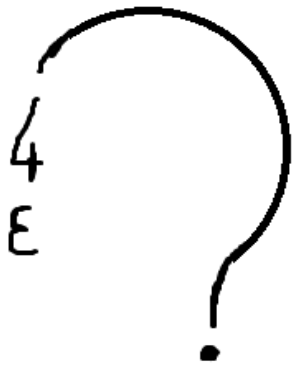

# La technique des figures géométriques ou dessin géométrique

## Les formes cubiques

### -Le foyer métallique

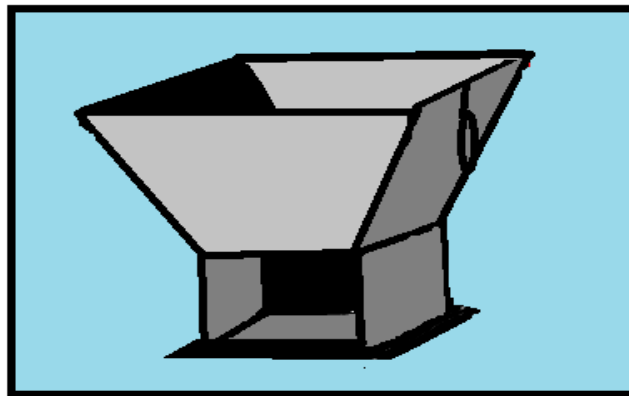
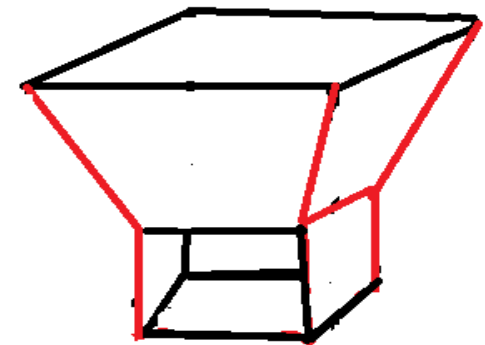
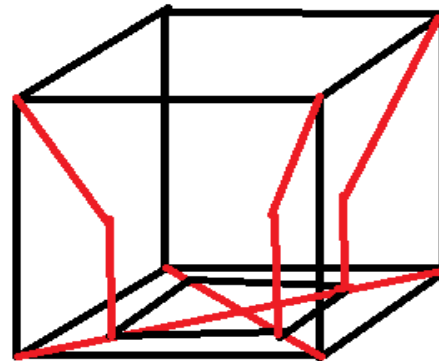
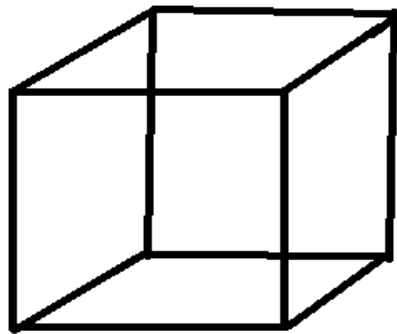

# Une boîte de craies ouverte et vide

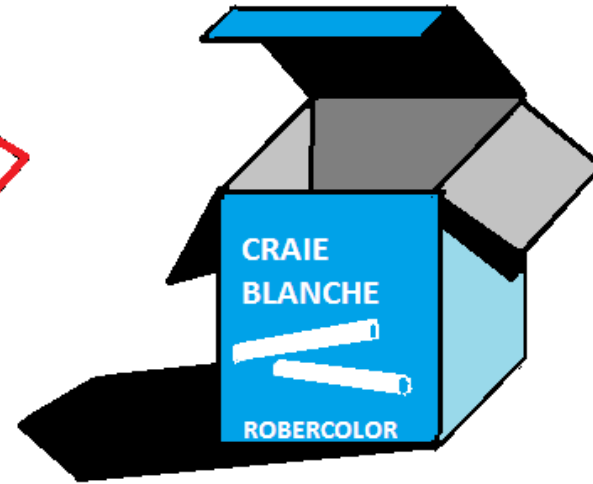
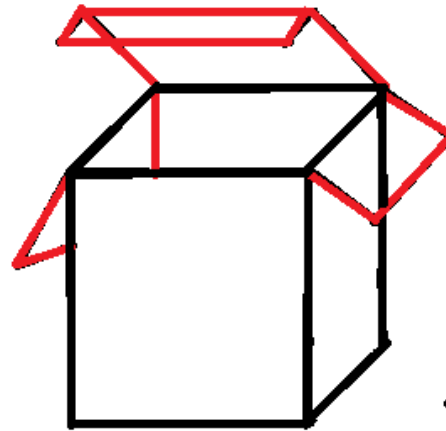
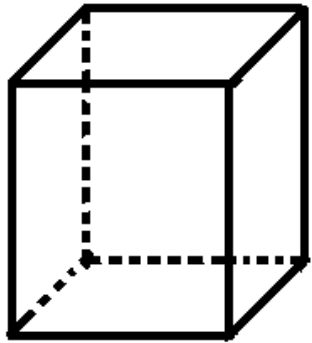

# Une boîte de craies fermée

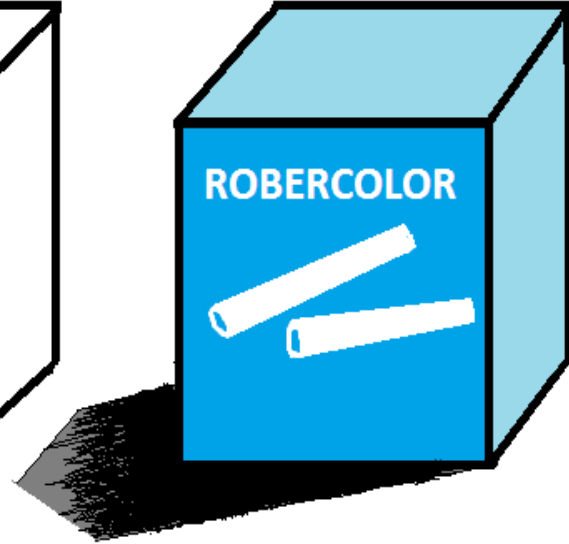
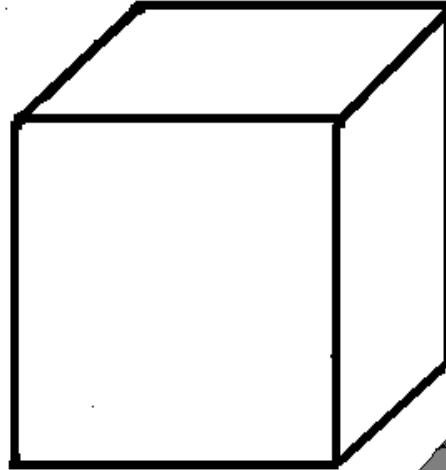
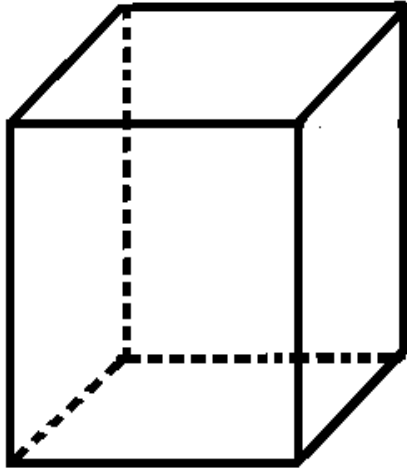

# La chaise

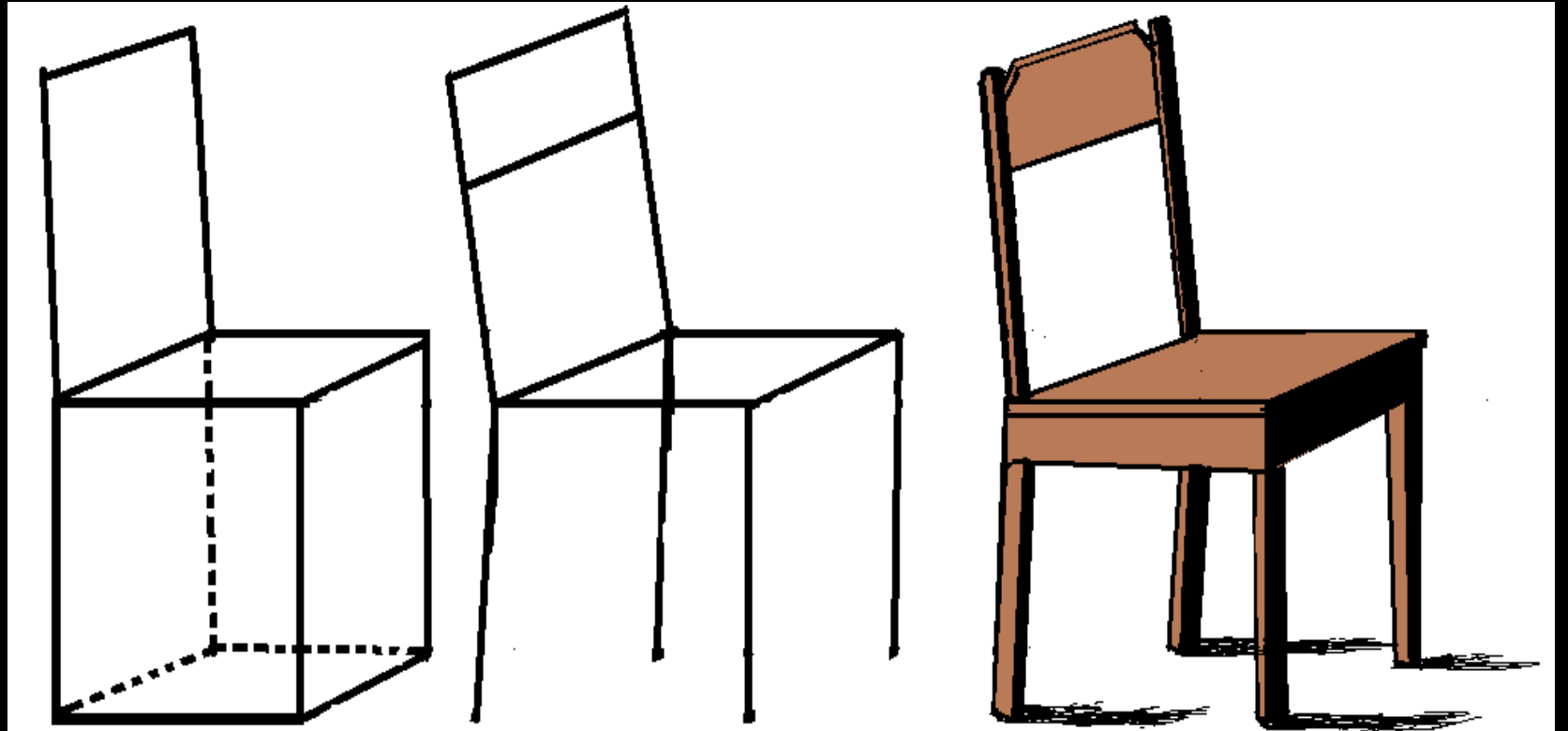

# Le dé ludique

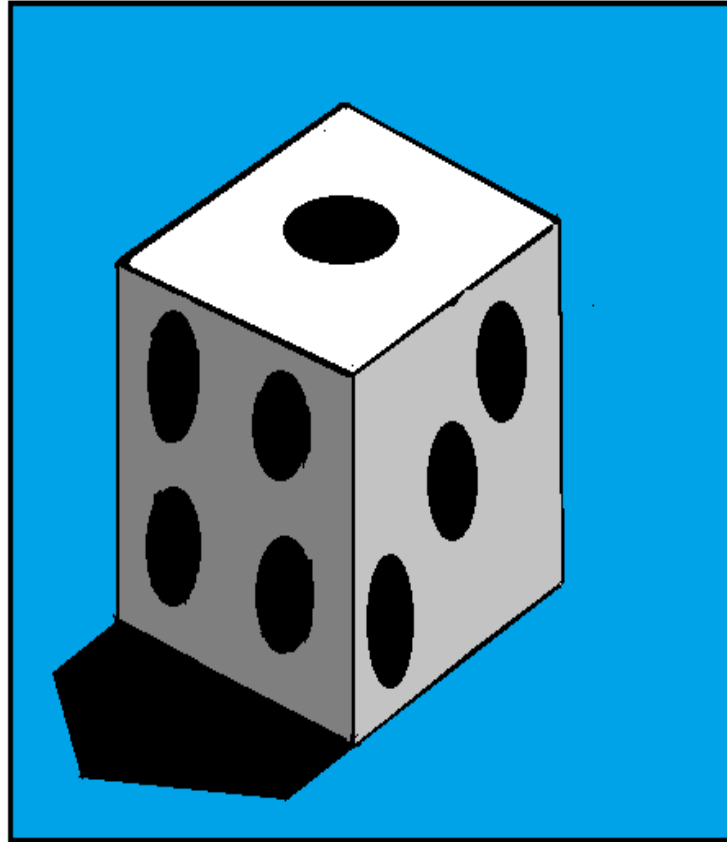
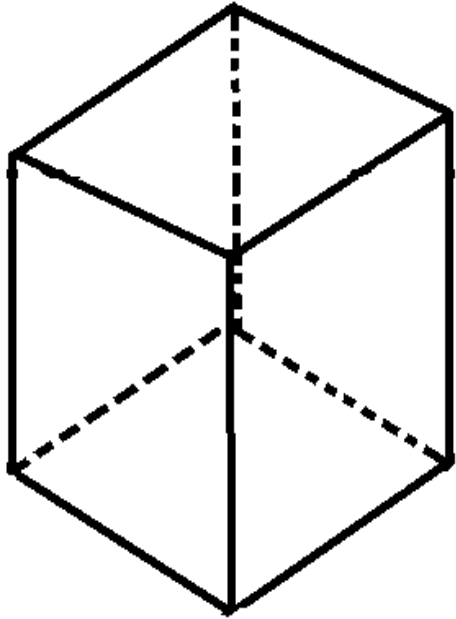

# Les objets de forme parallélépipédique

## La table

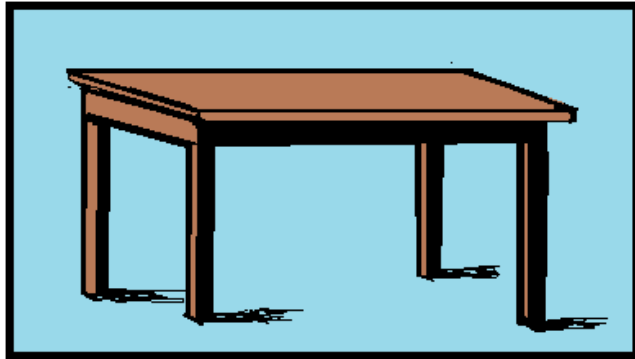
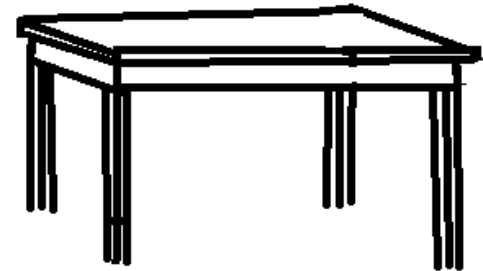
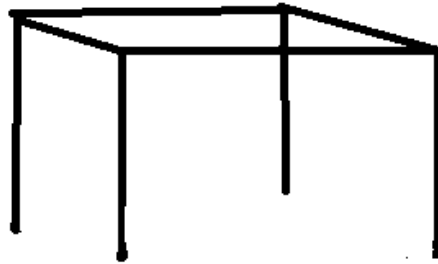
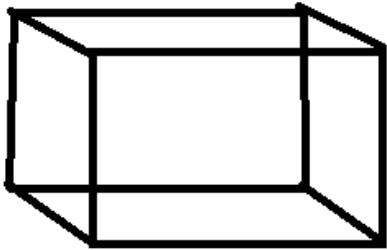

# Le livre ouvert

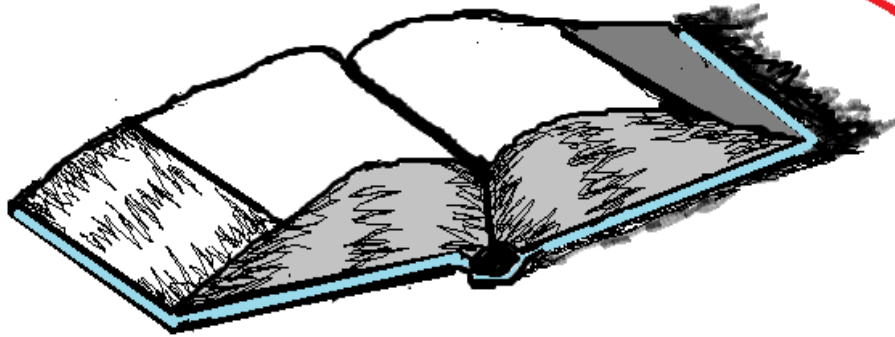
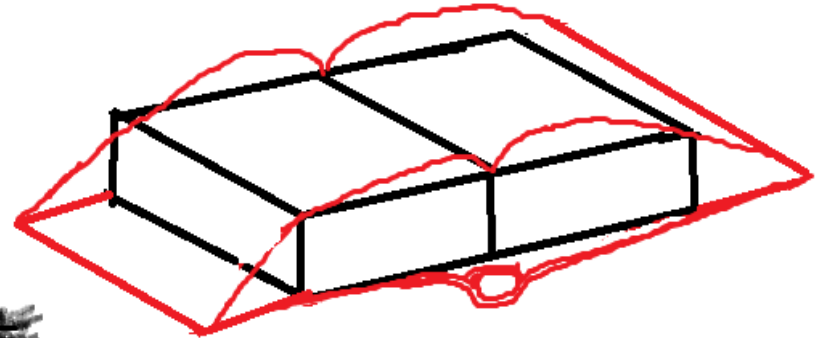
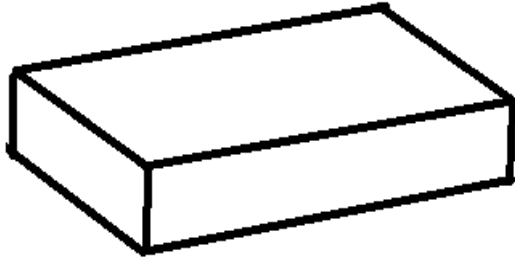

# Le livre ouvert

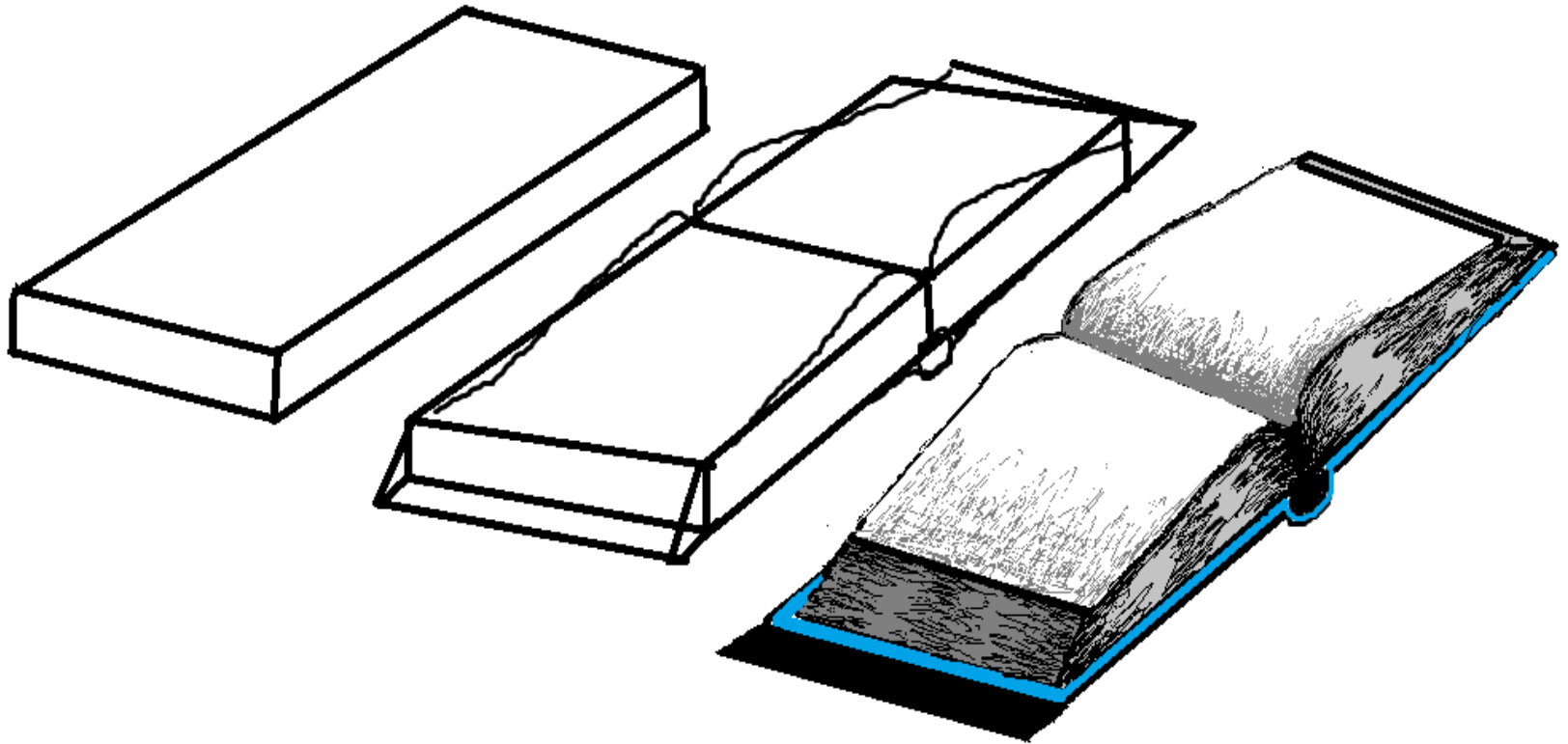

# Le livre fermé

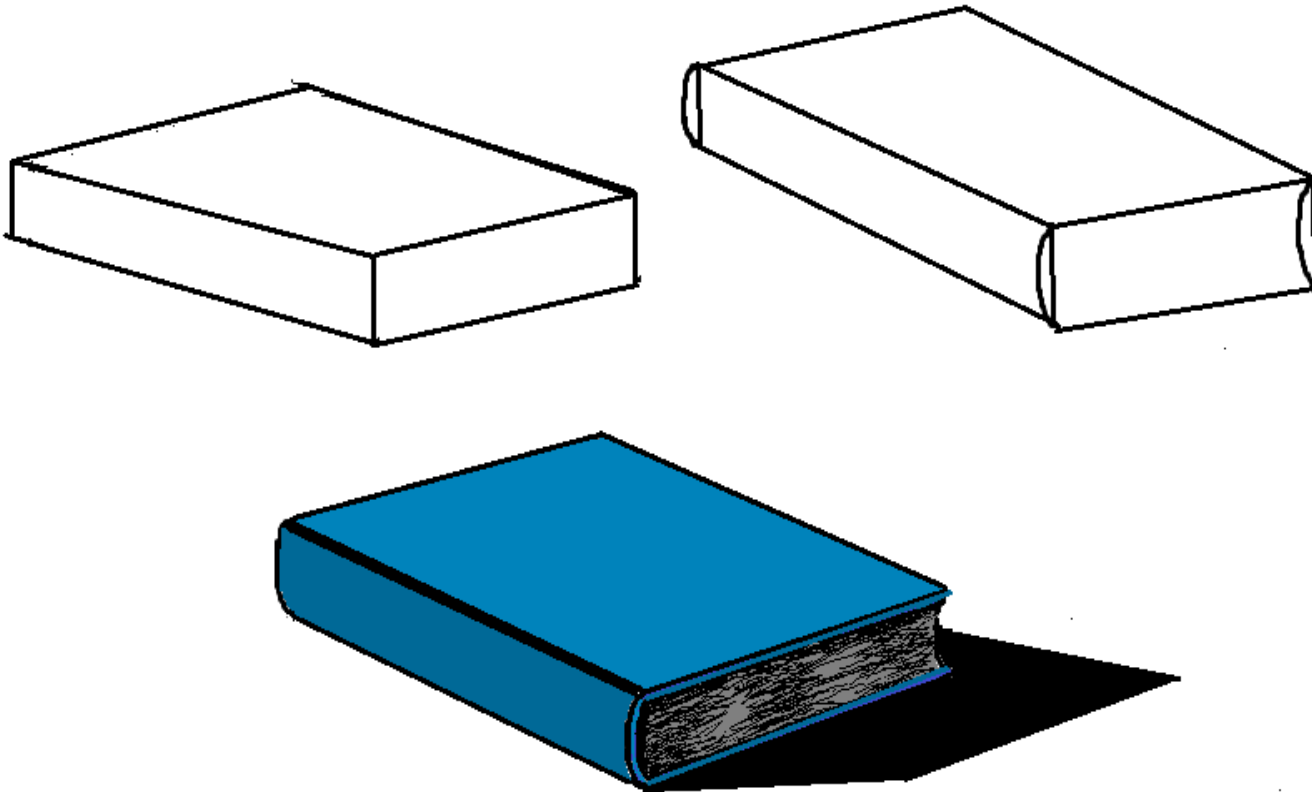

# Une pile de livres

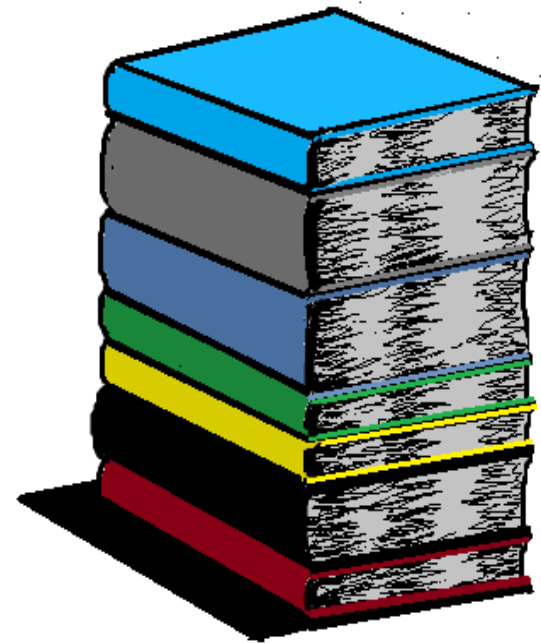
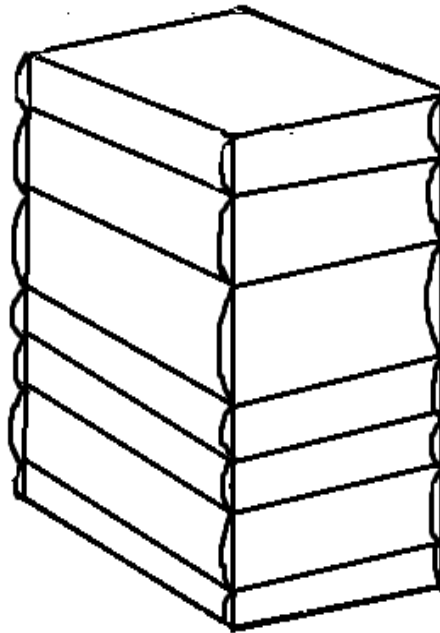
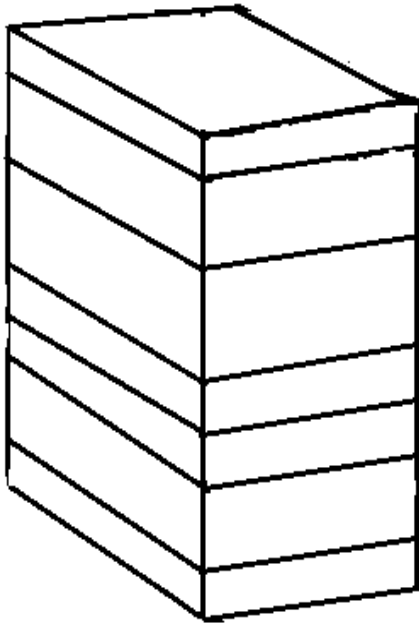

# Un banc d'écolier

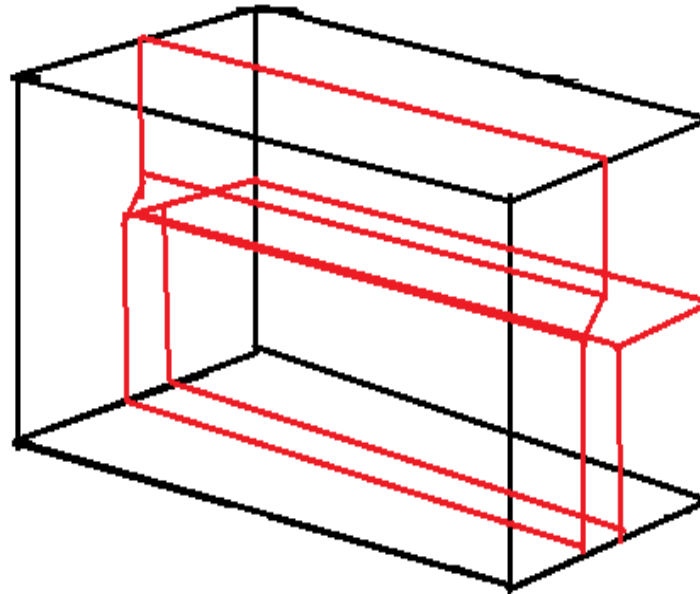
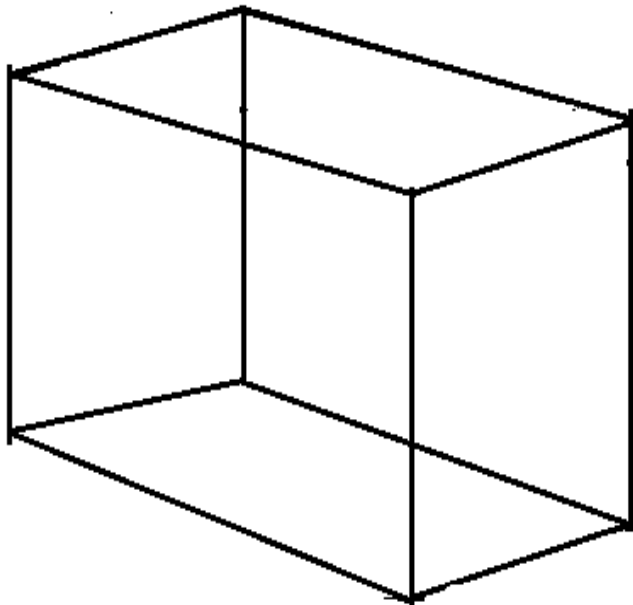

# Un banc d'écolier

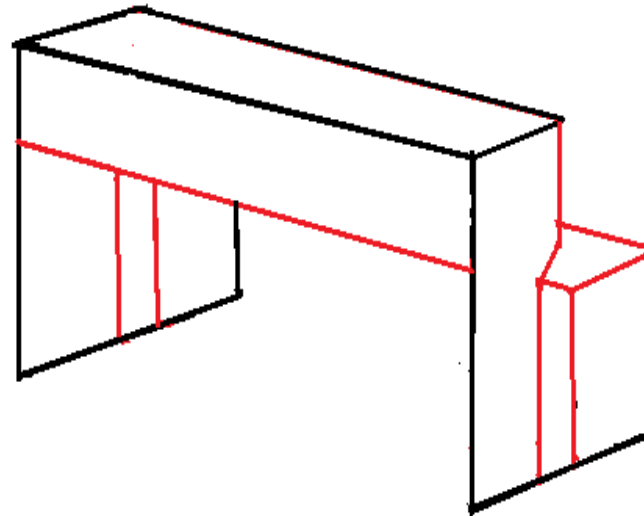

# Un banc d'écolier

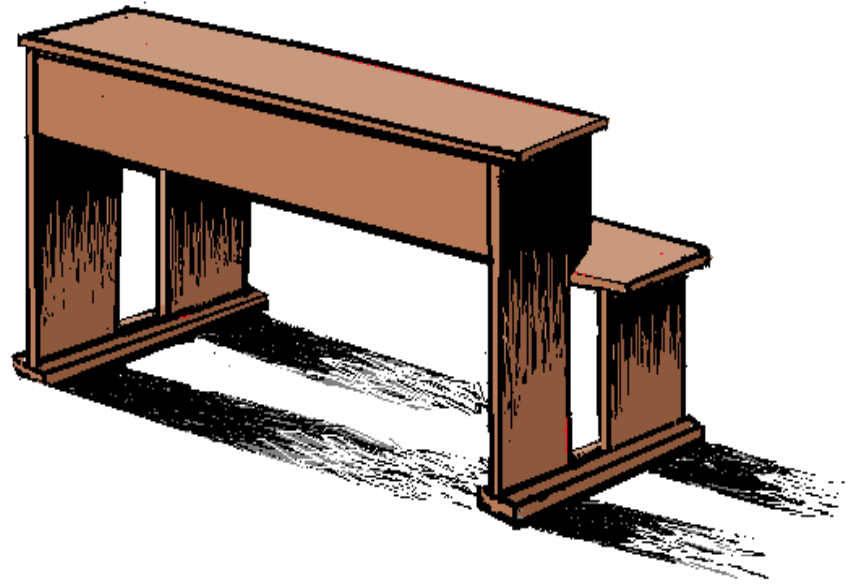

# Une case

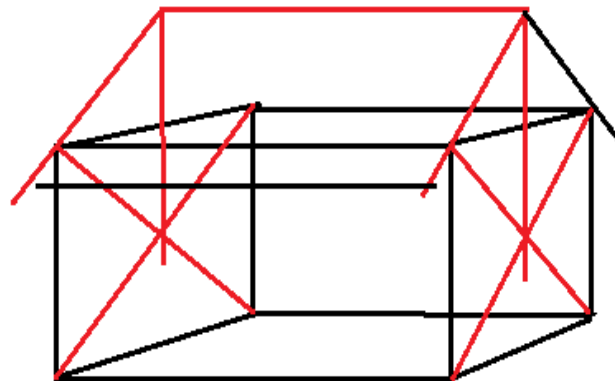
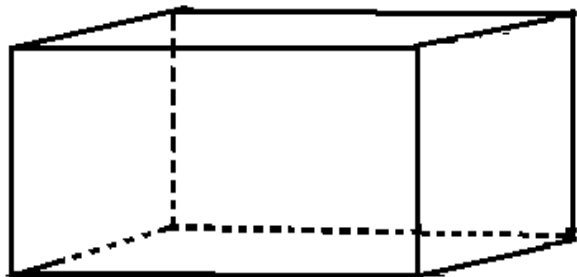

# Un livre ouvert posé sur une table

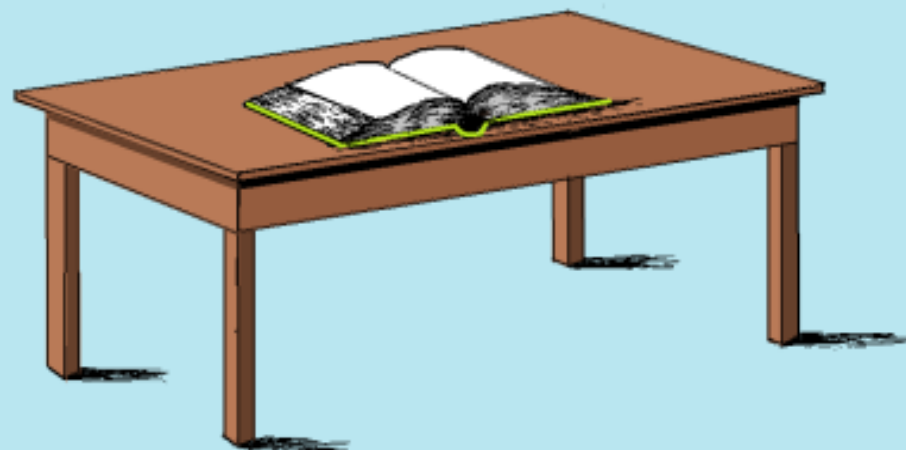

# La radio

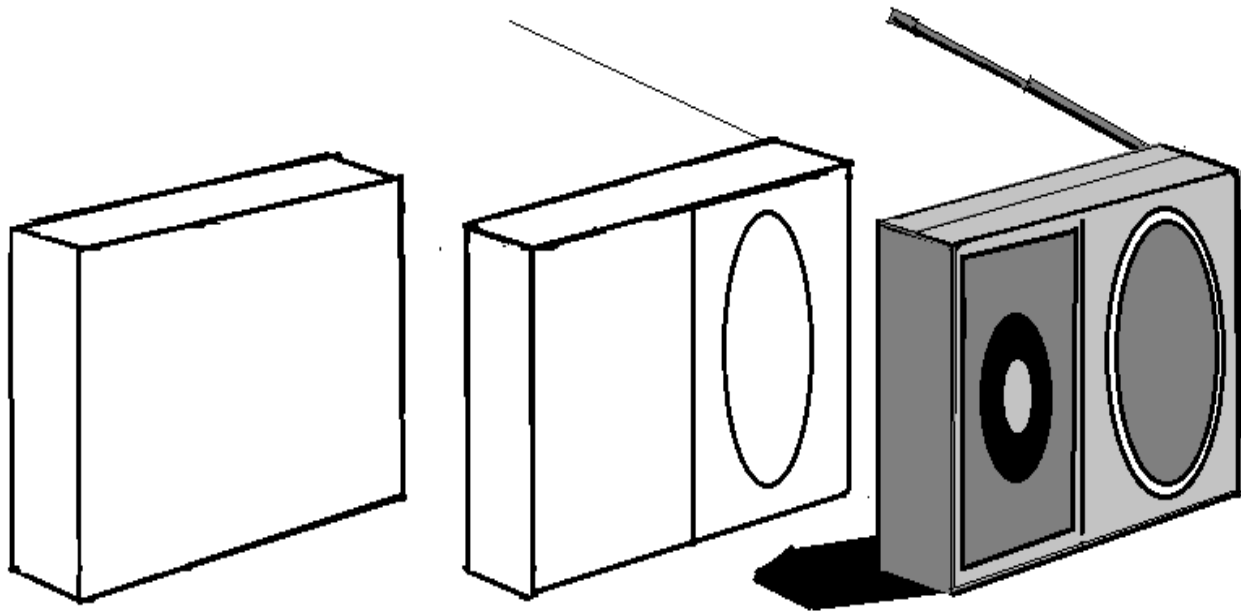

# La télévision

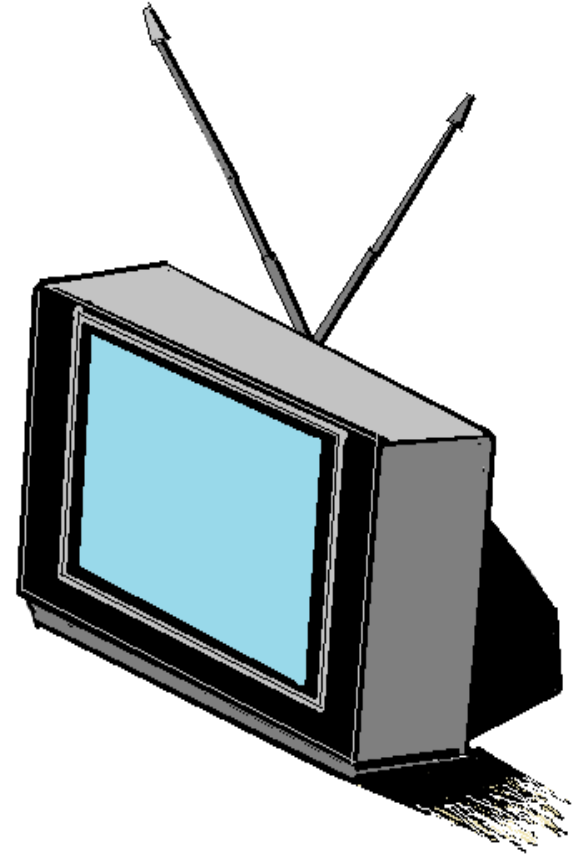
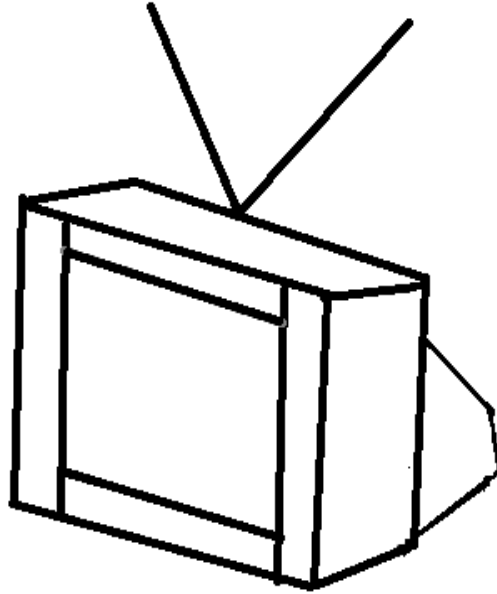
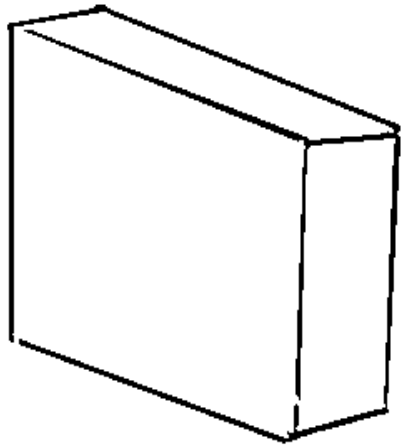

# Le téléphone portable

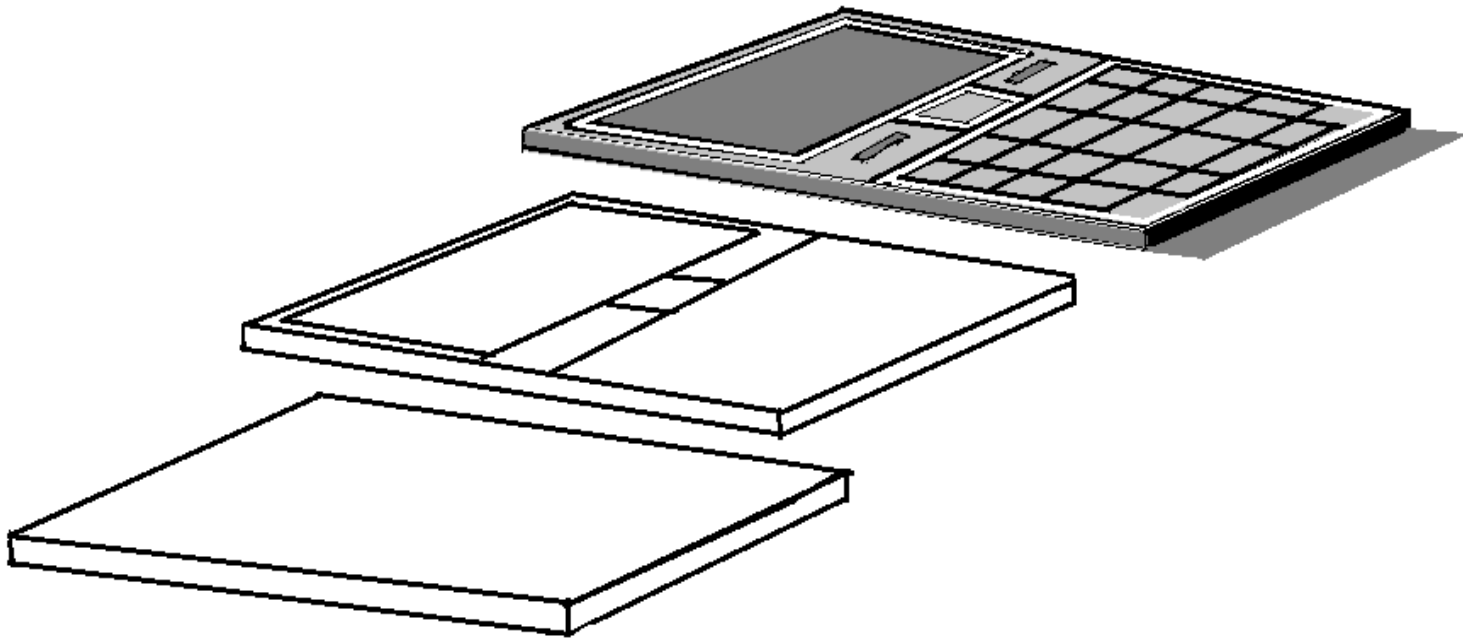

# Le foyer traditionnel

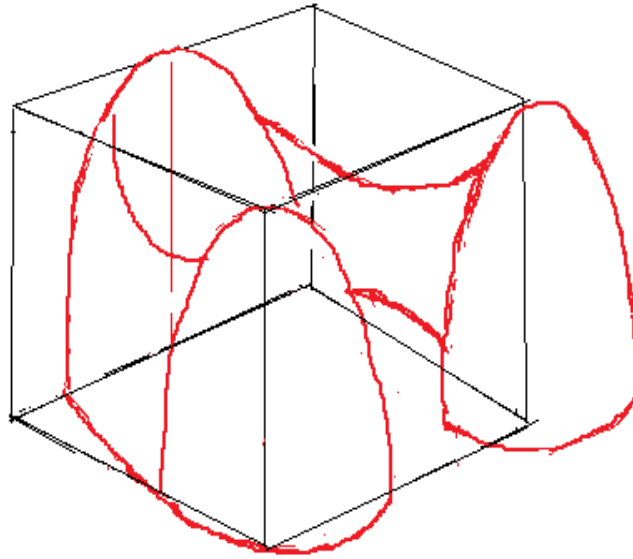
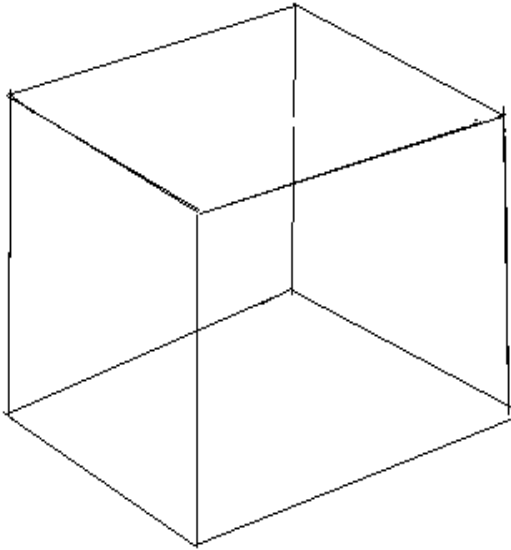

# Le foyer traditionnel

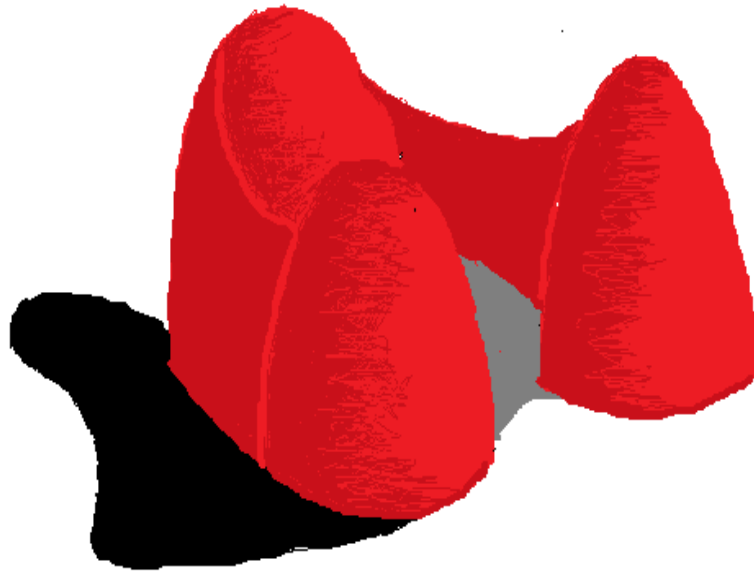

# Les lunettes

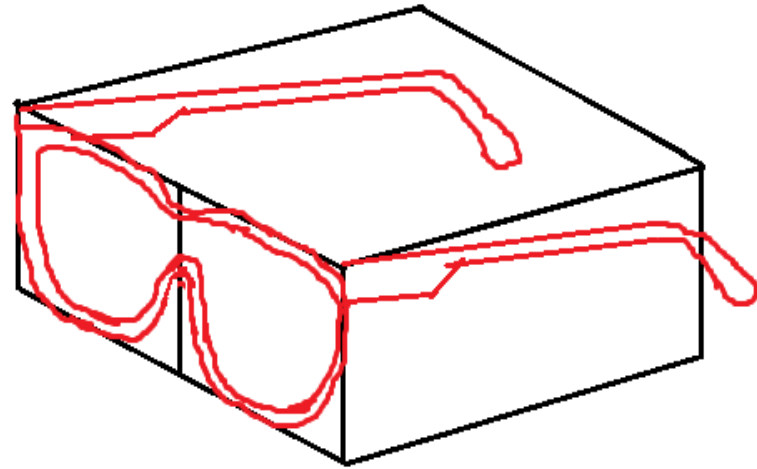
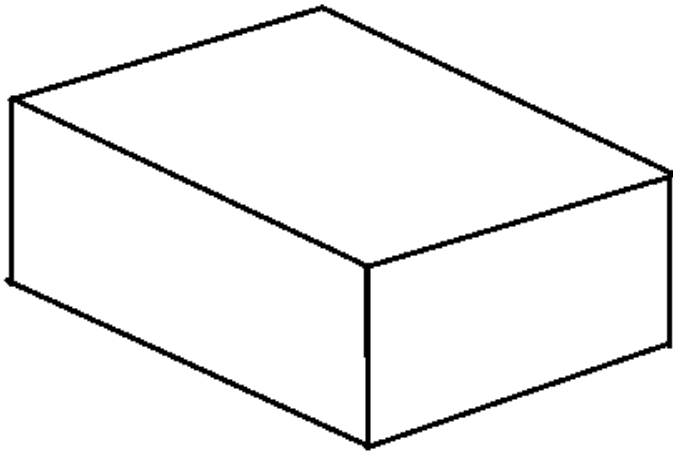

# Les lunettes

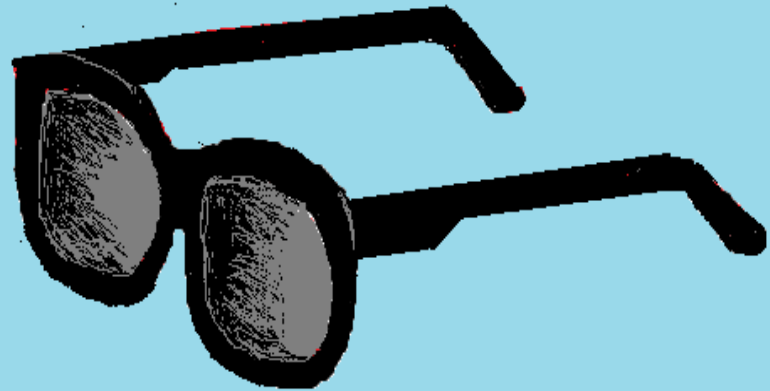

# Une voiture vue en perspective oblique gauche

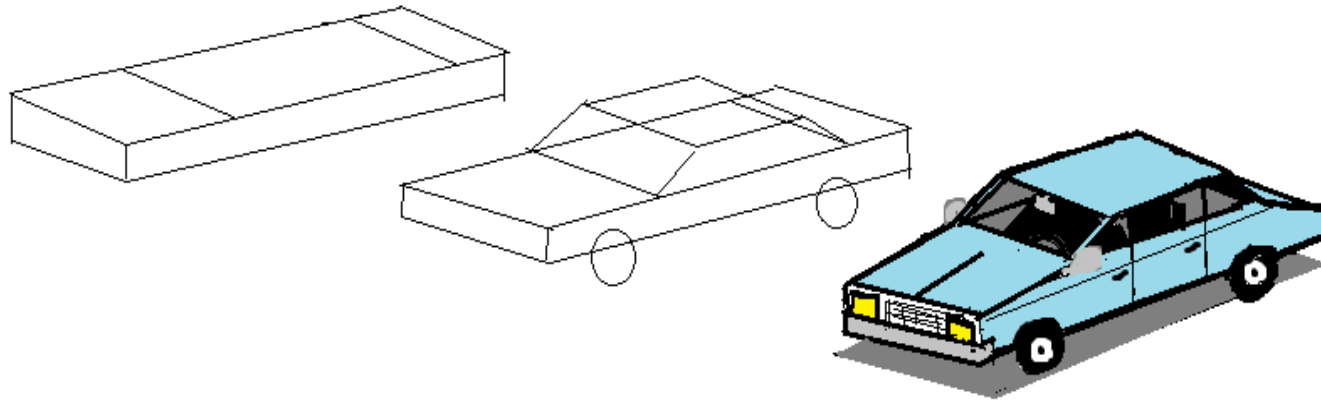

# Les objets de forme cylindrique

## La bouteille et le verre



# Le mortier

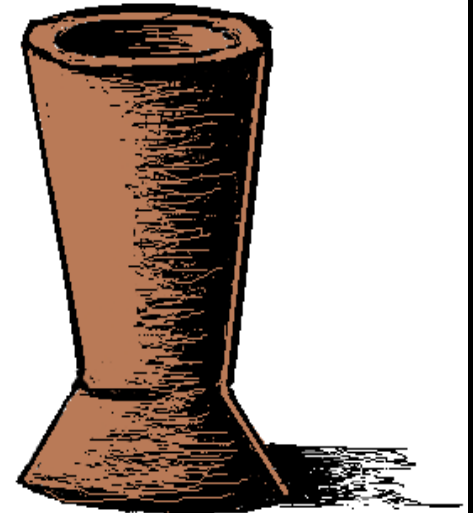
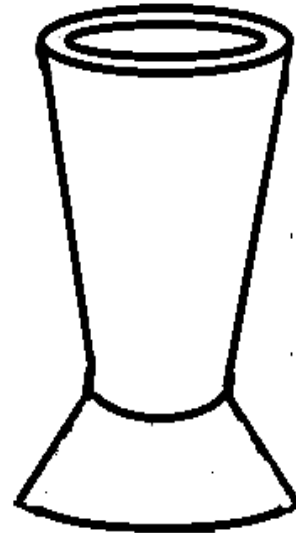
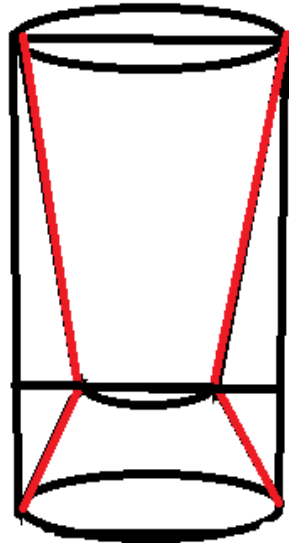
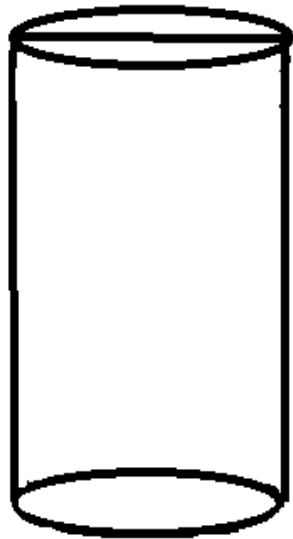

# Le tonneau

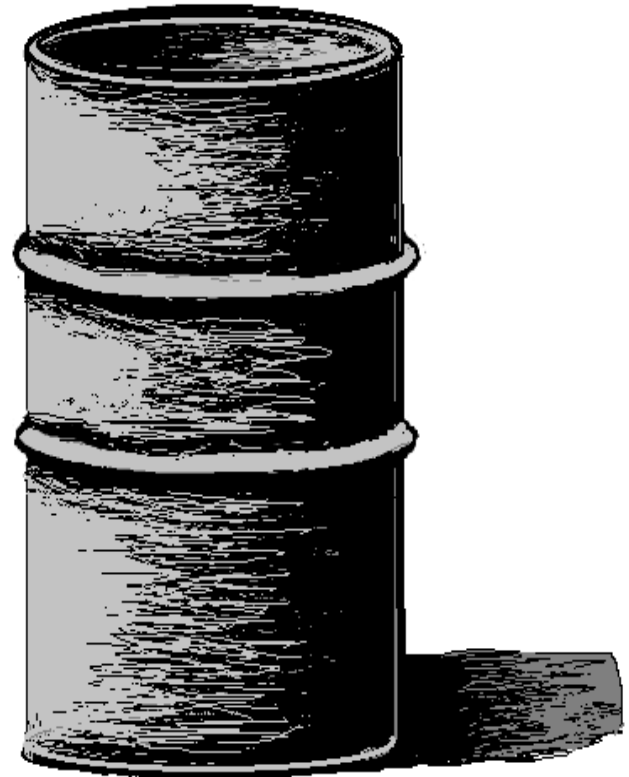
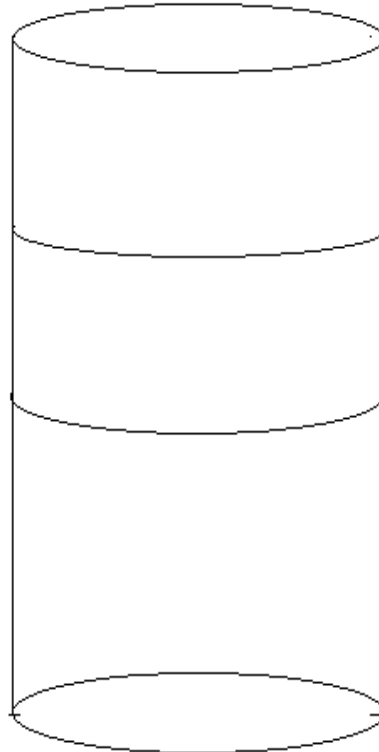
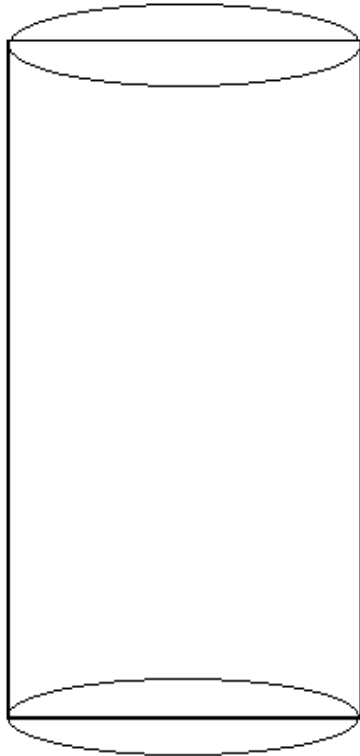

# La casserole

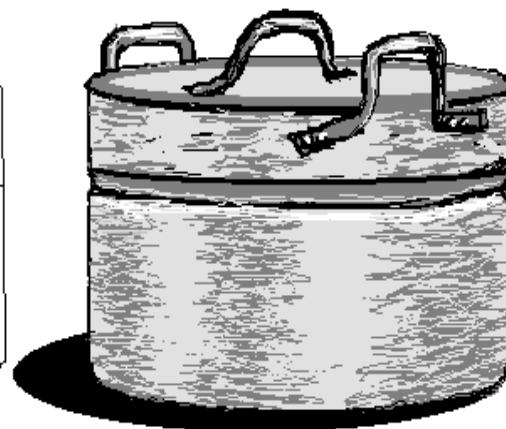
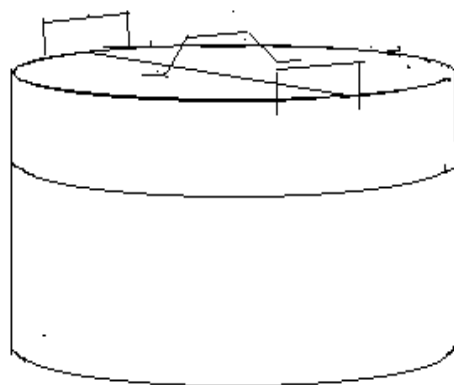
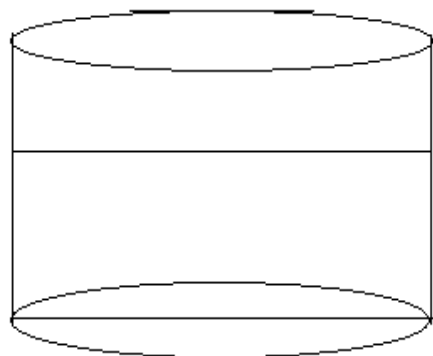

# Le seau

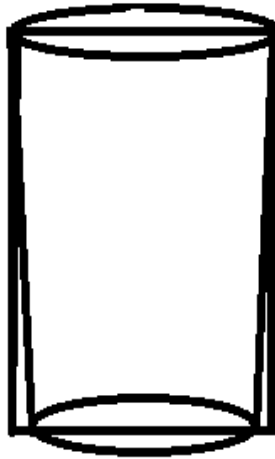
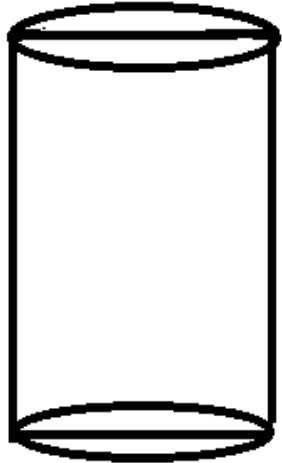

# Le gobelet

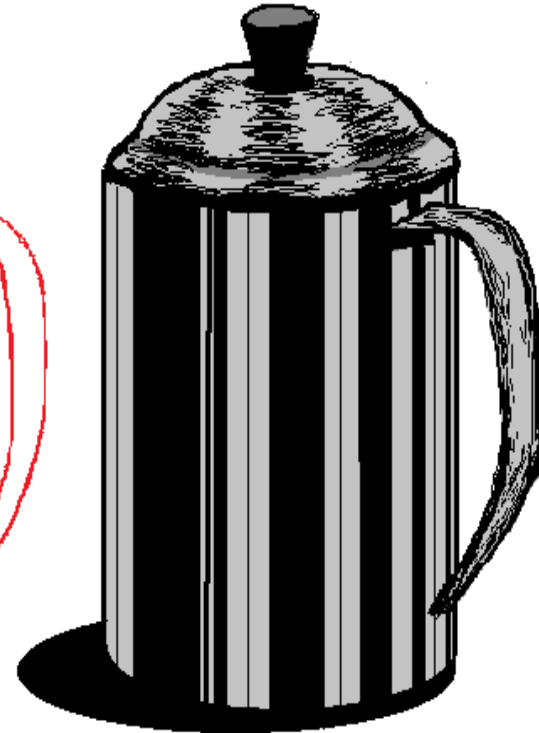
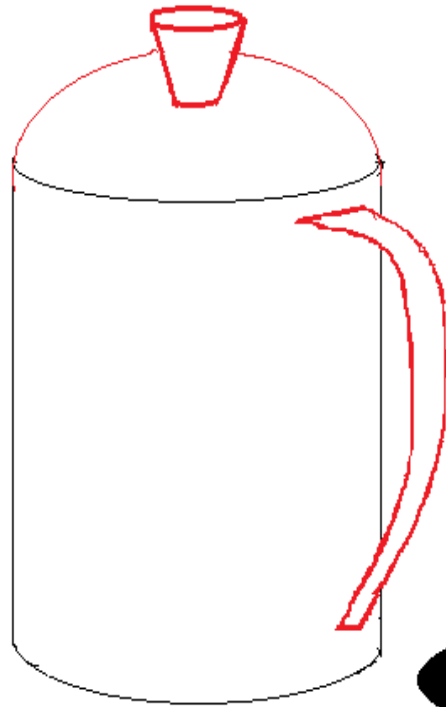
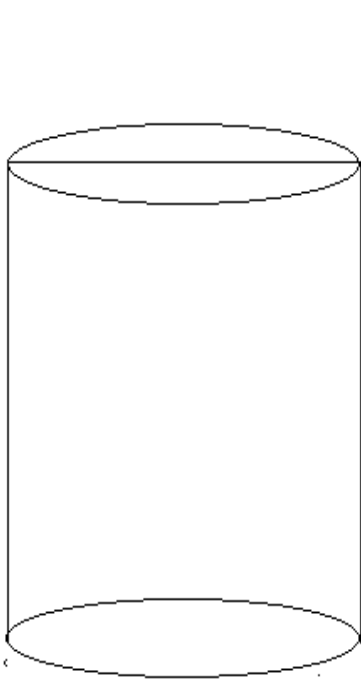

# La torche

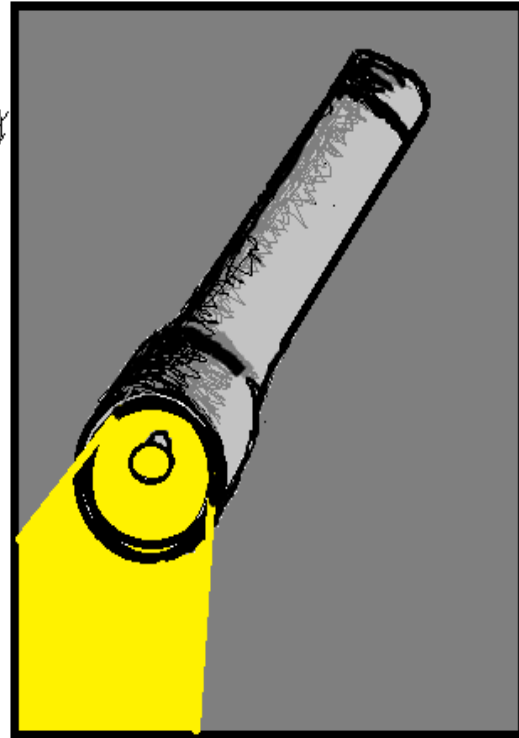
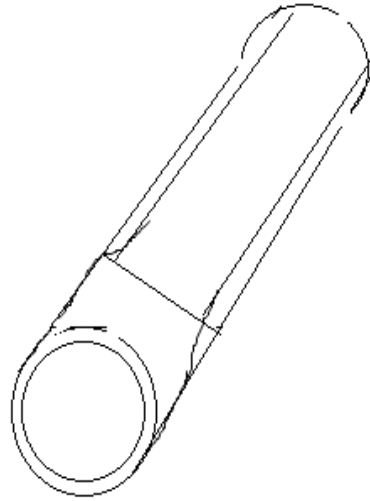
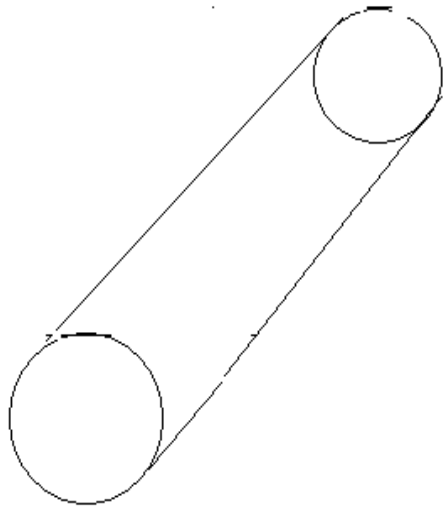

# Les formes sphériques

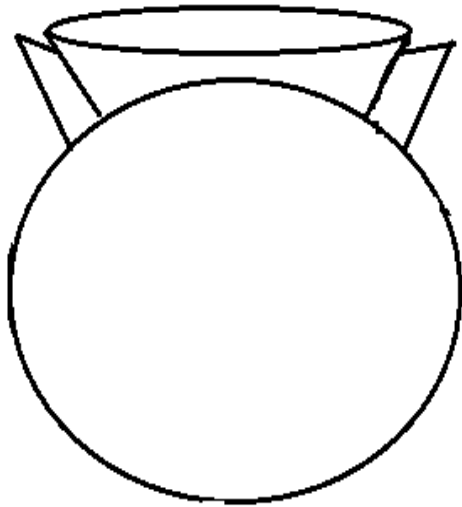

# Le ballon de foot

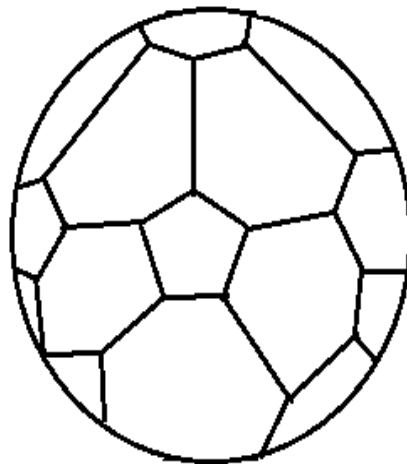
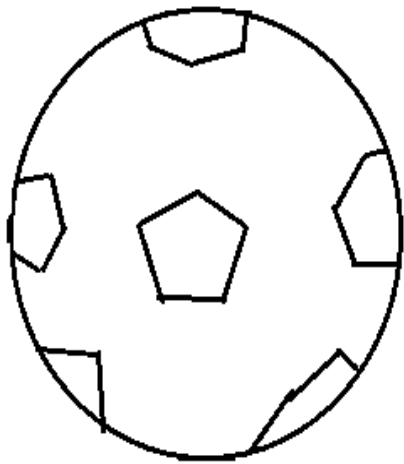

# Le canari

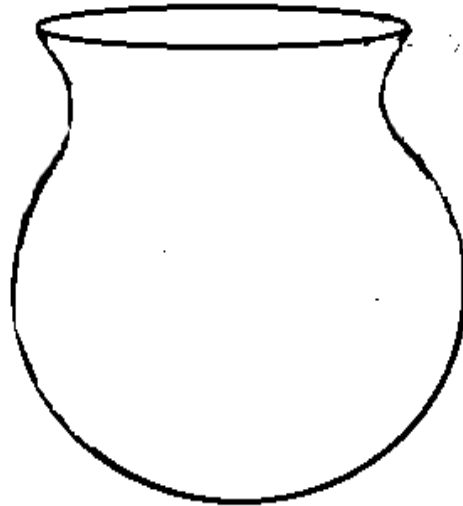
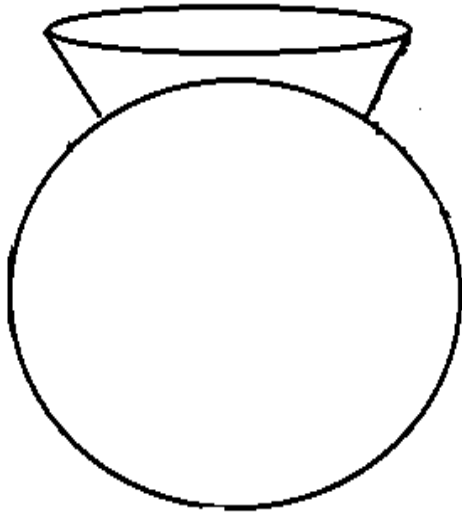

# La calabasse

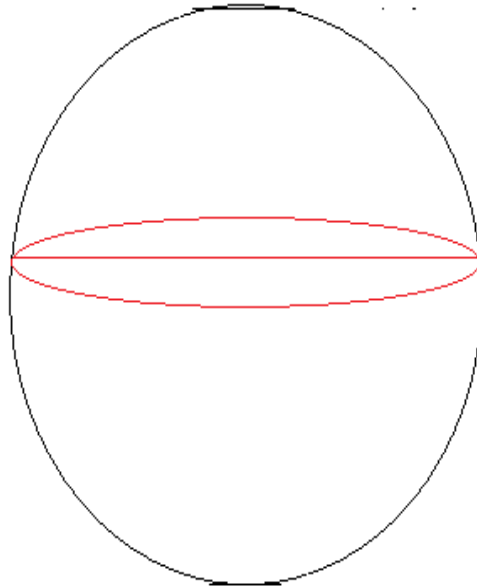
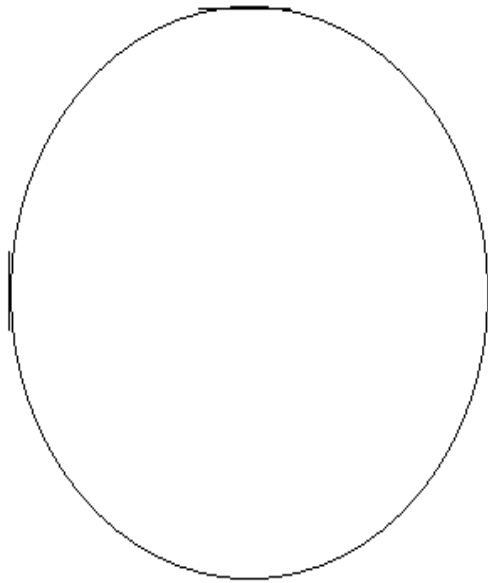

# Les oranges regroupées

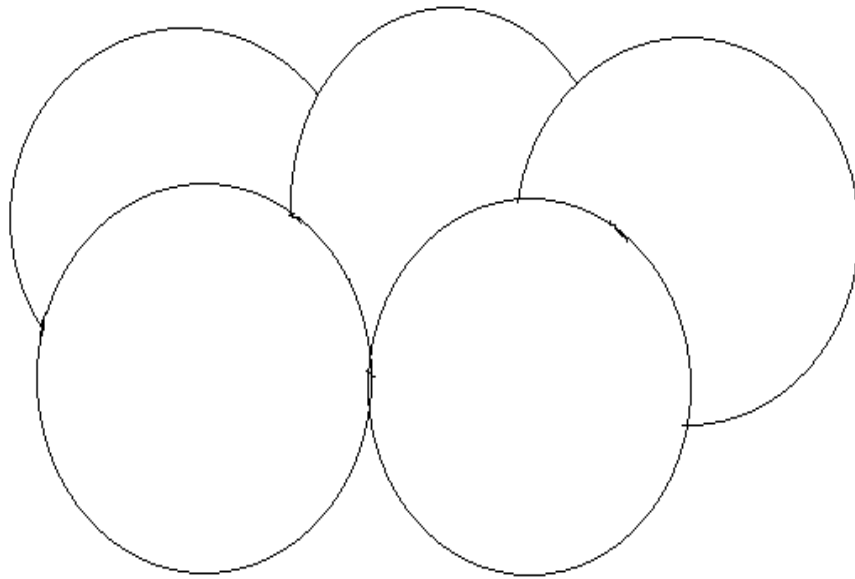

# Les oranges regroupées

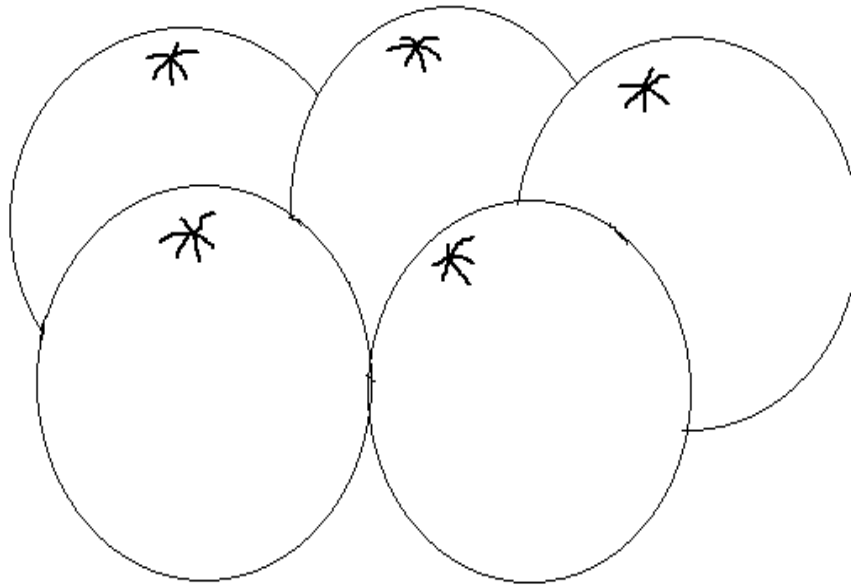

# Les oranges regroupées

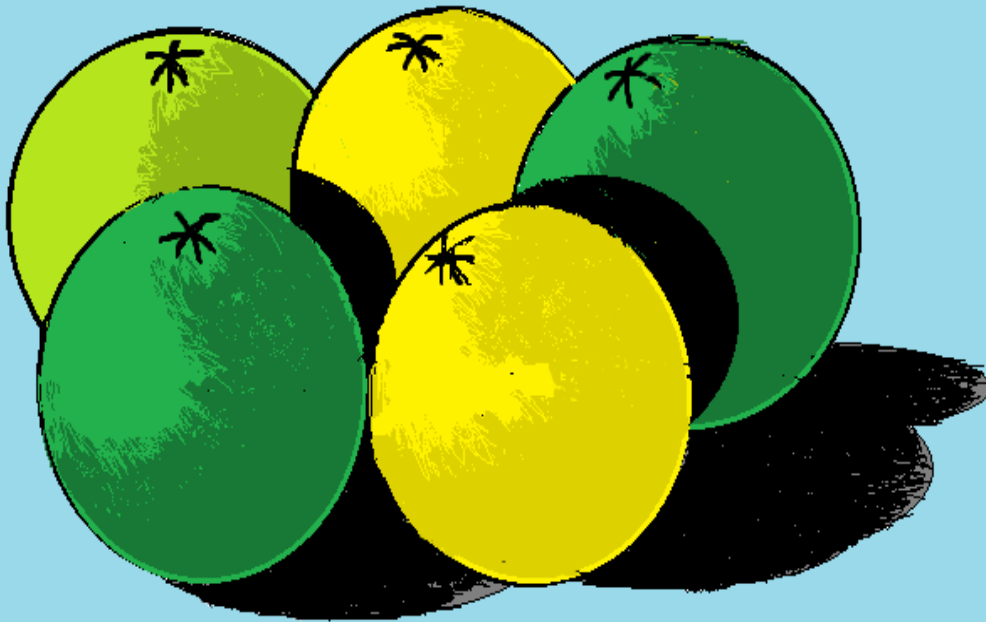

# Les objets de forme conique

## Case ronde couverte de pailles

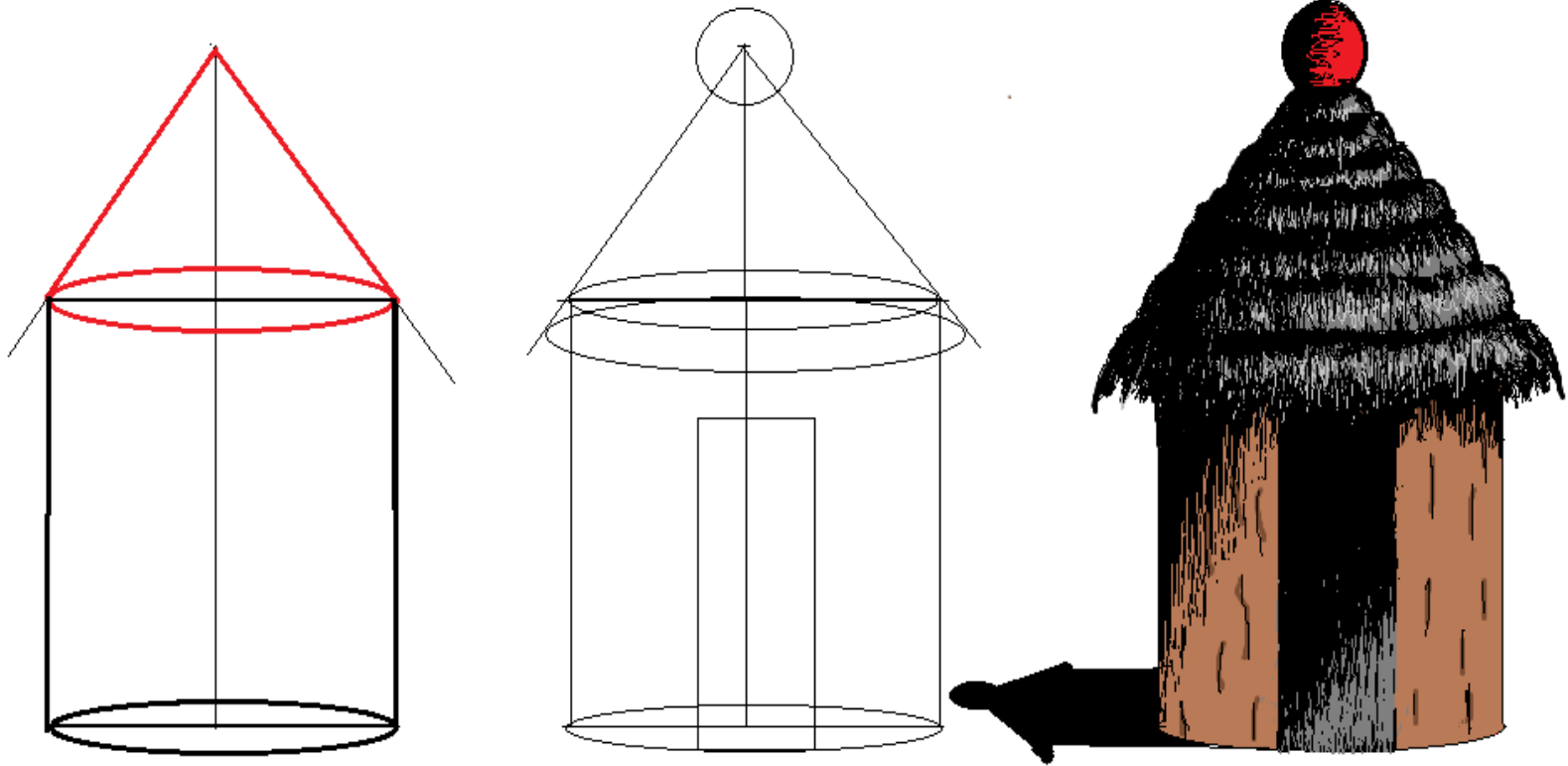

# Une paillette

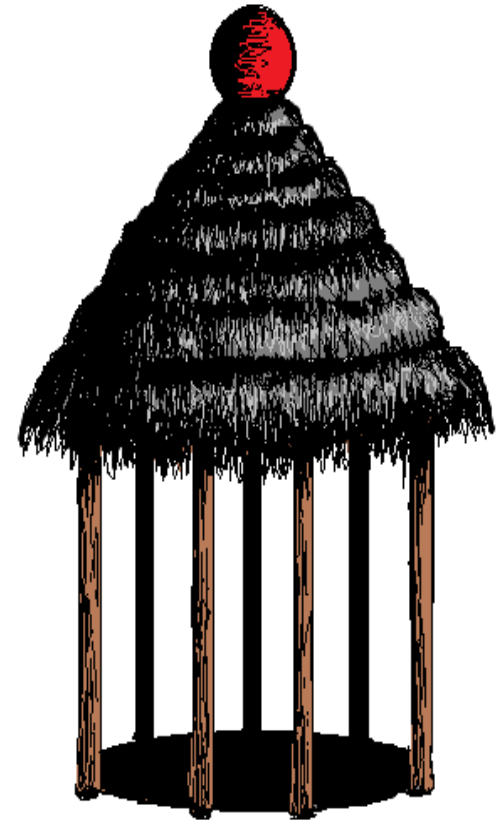
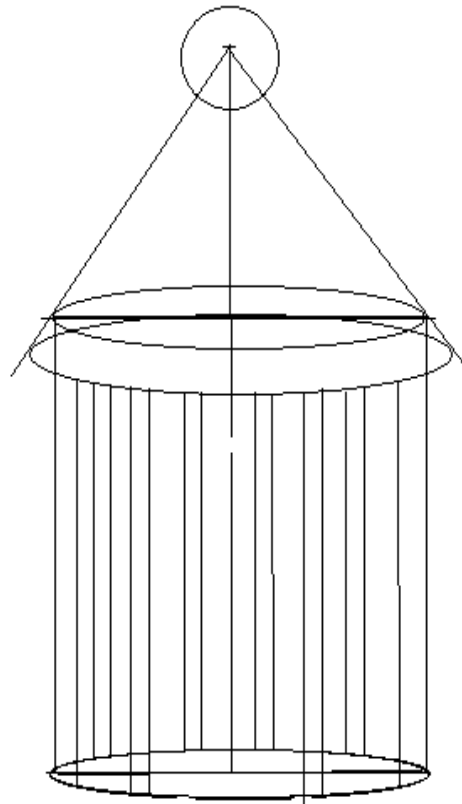
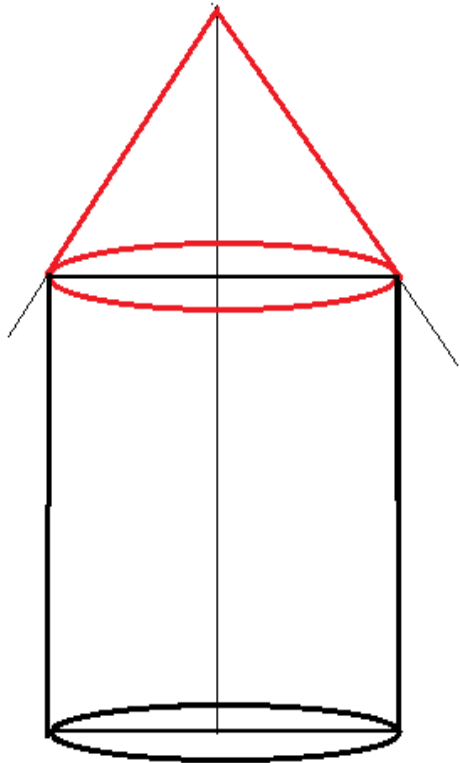

# Un entonnoir

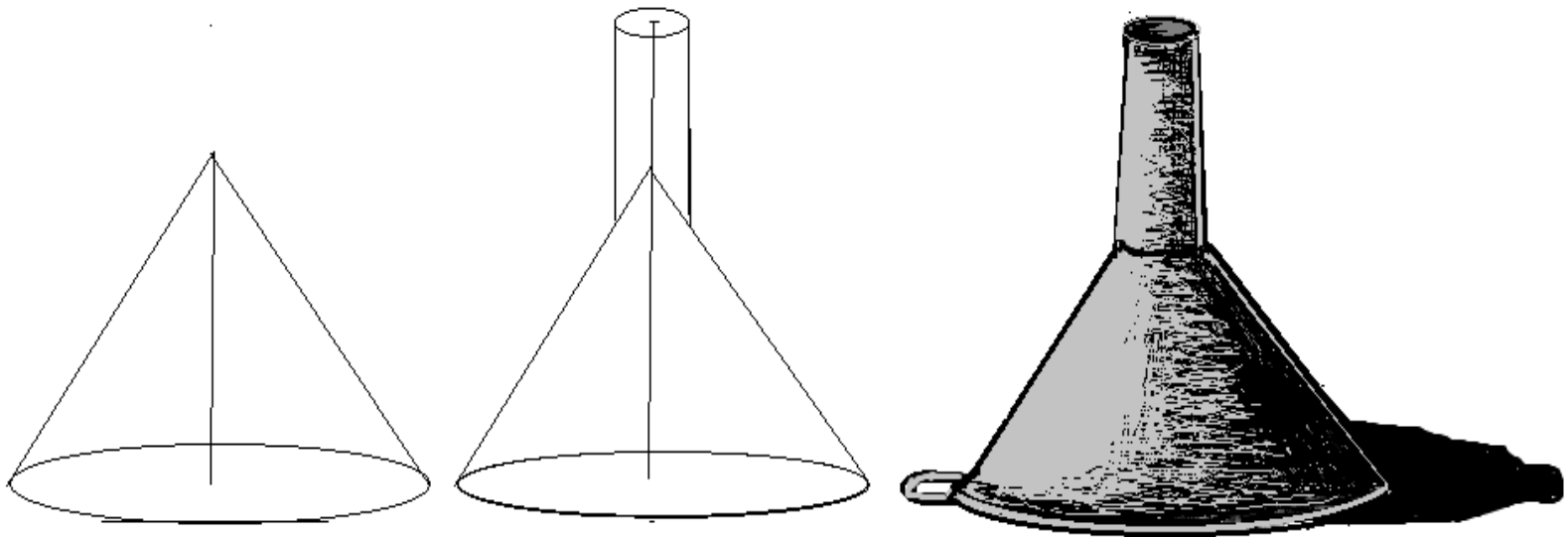

## Les objets de forme prismatique un bâtiment ou une case

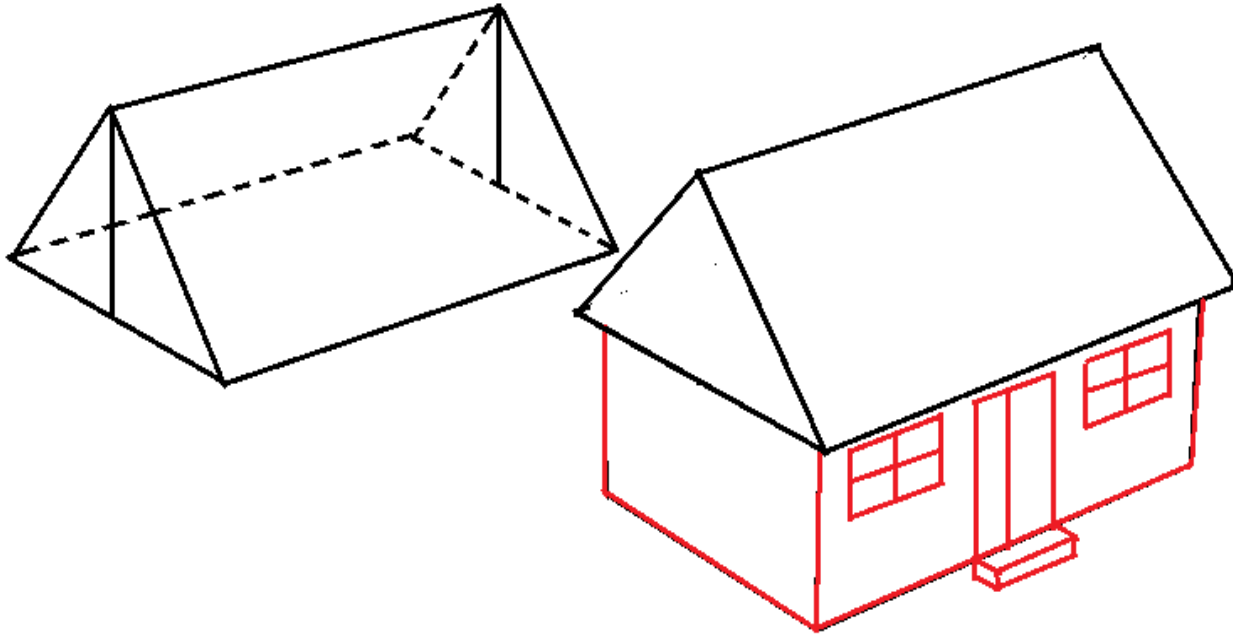

# Un bâtiment ou une case

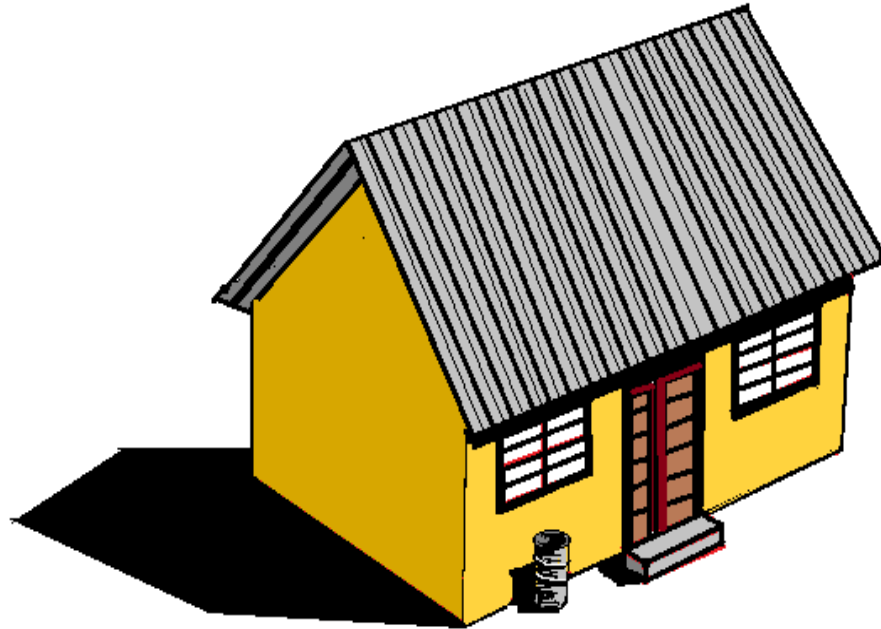

# Les dessins d'objets par les formes planes

## Le papillon

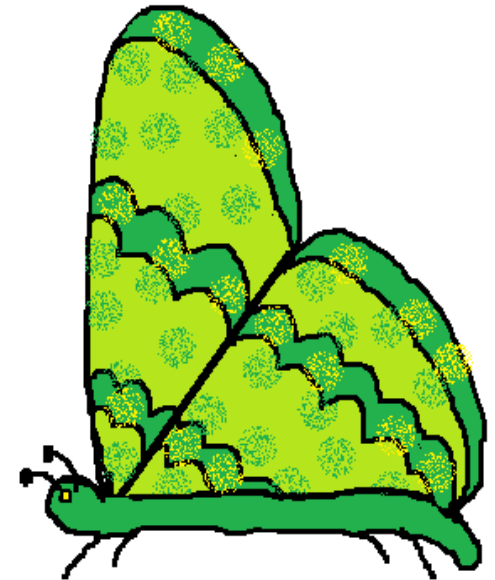
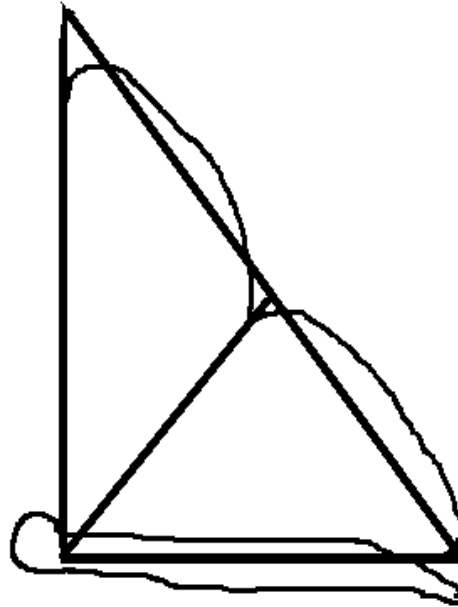
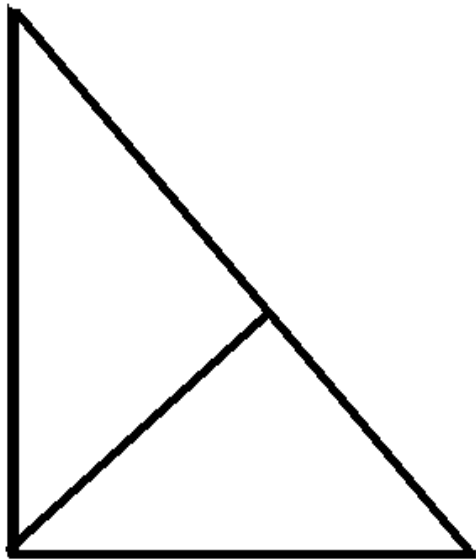

# Le papillon

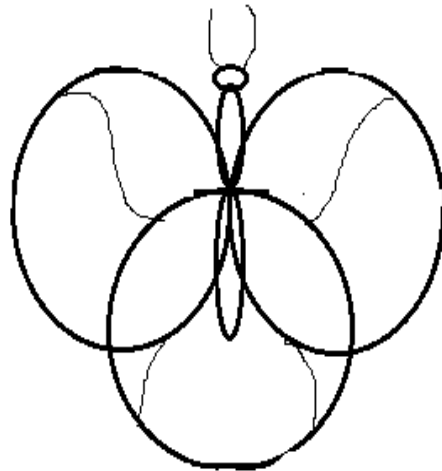
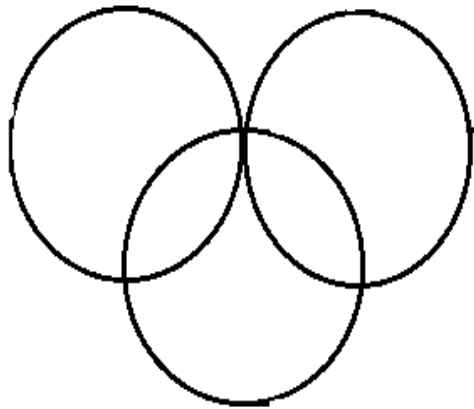

# Le parapluie

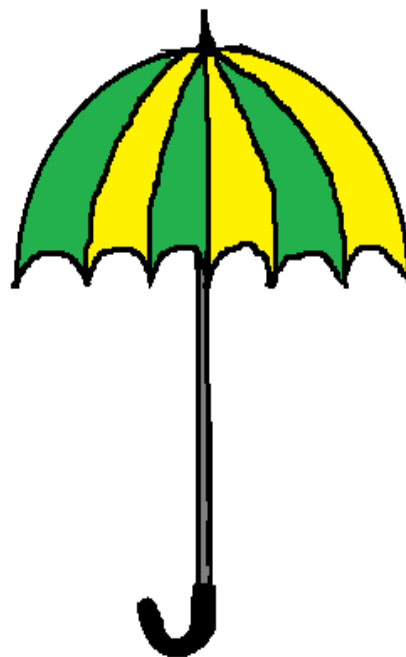
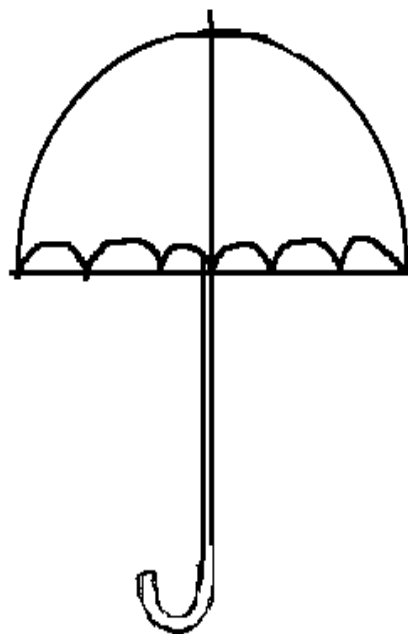
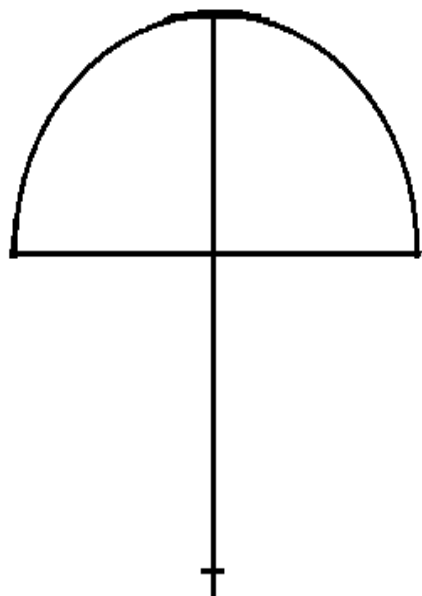

# Le plat

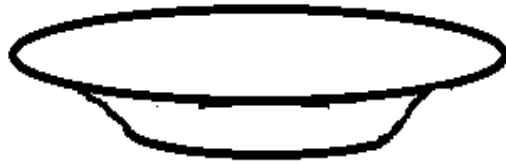

# La jarre

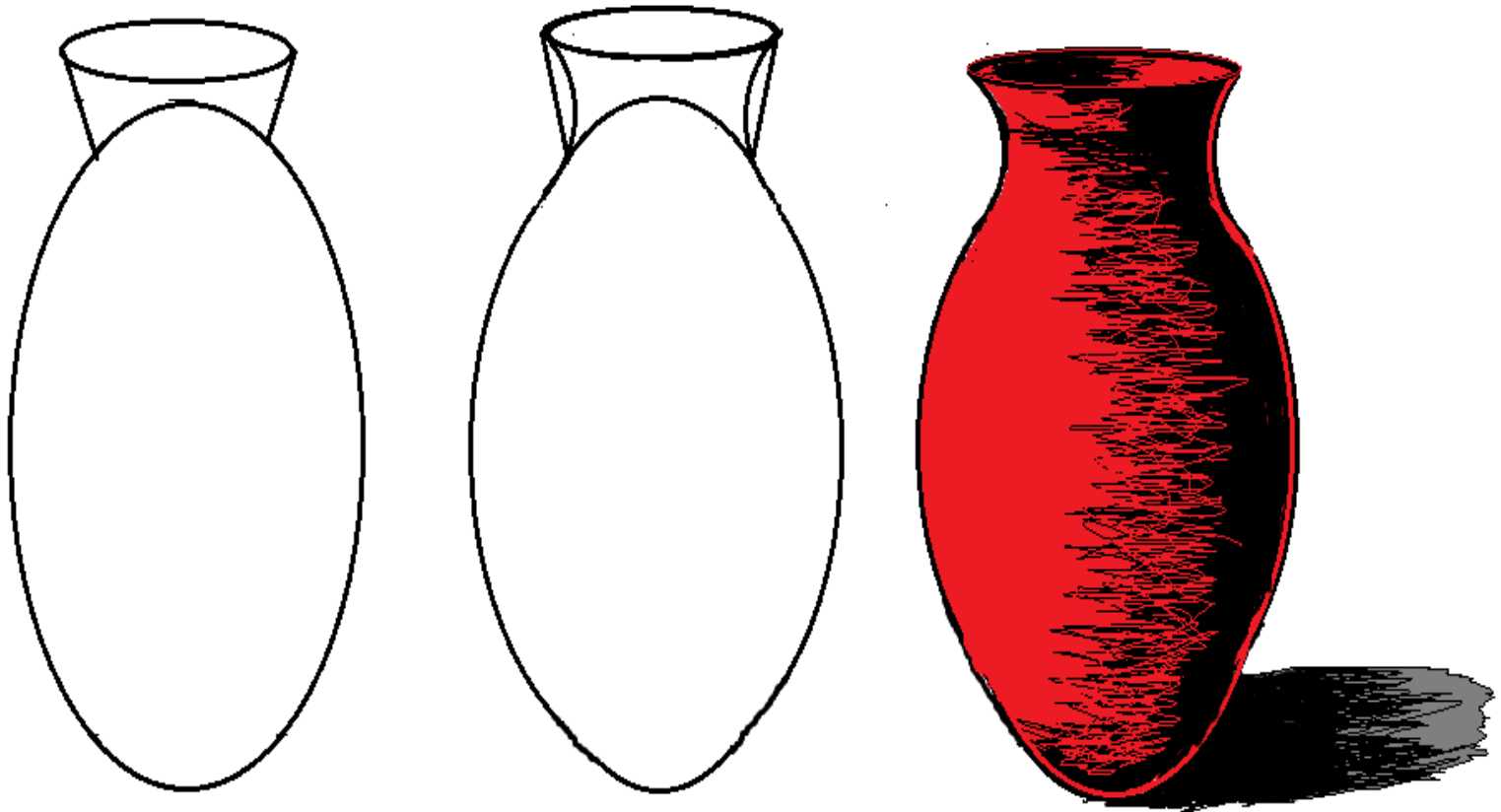

# Le chien assis

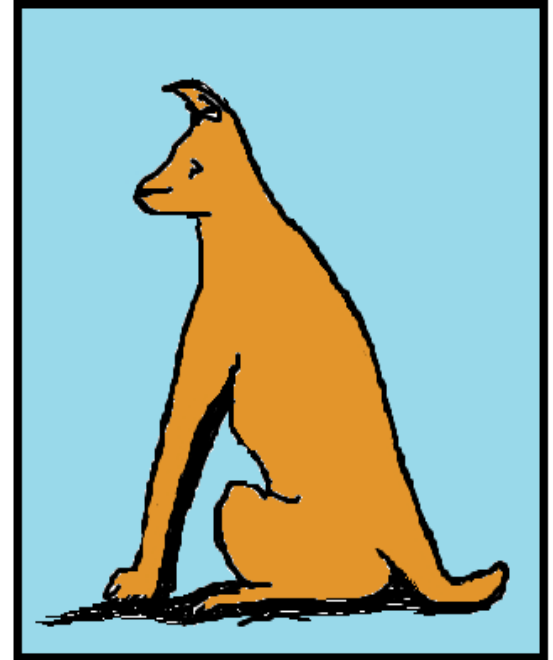
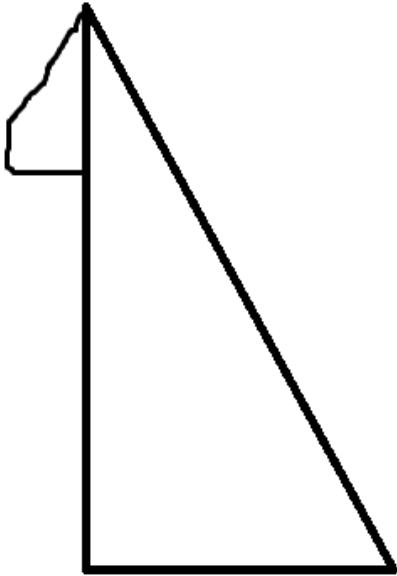

# Le mouton

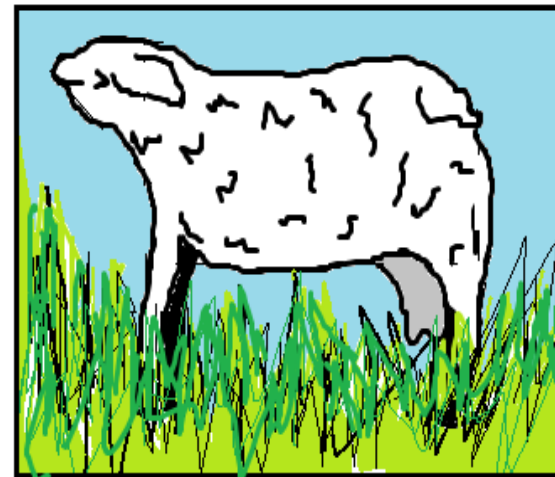
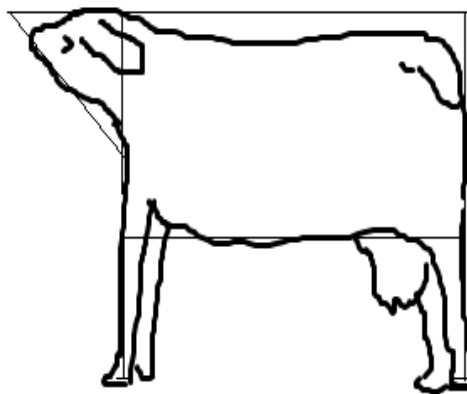
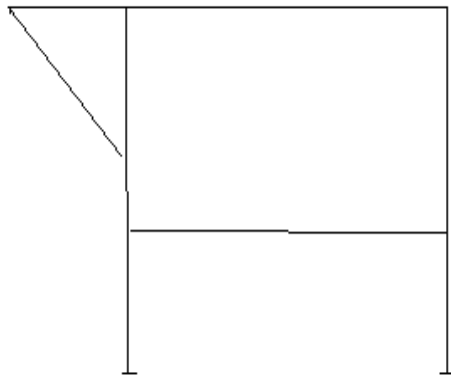

# Le coq

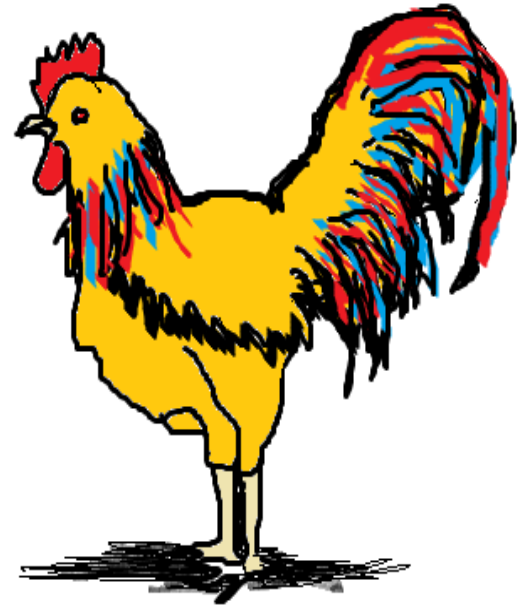
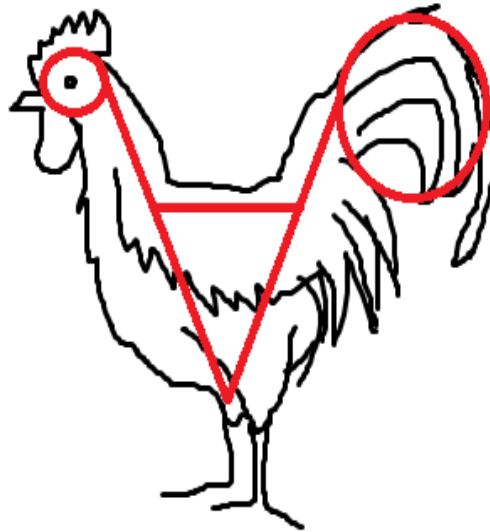
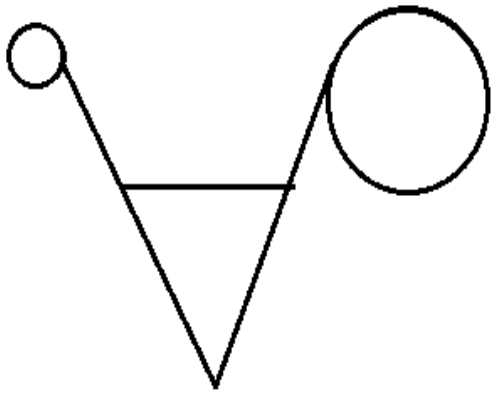

# La poule

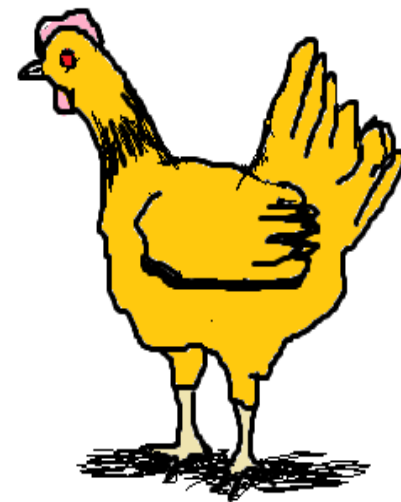
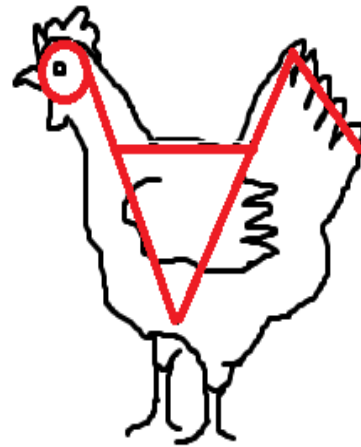
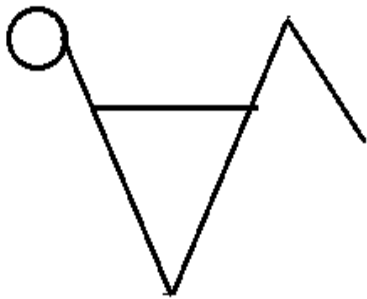

# Le poussin

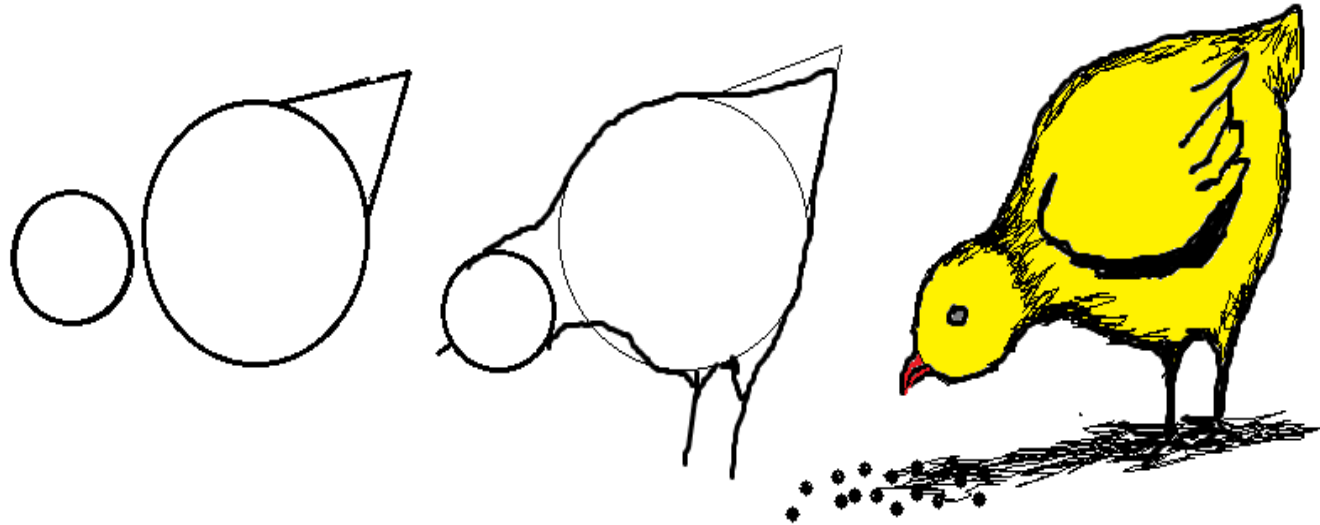

# Le chat assis vu de profil gauche

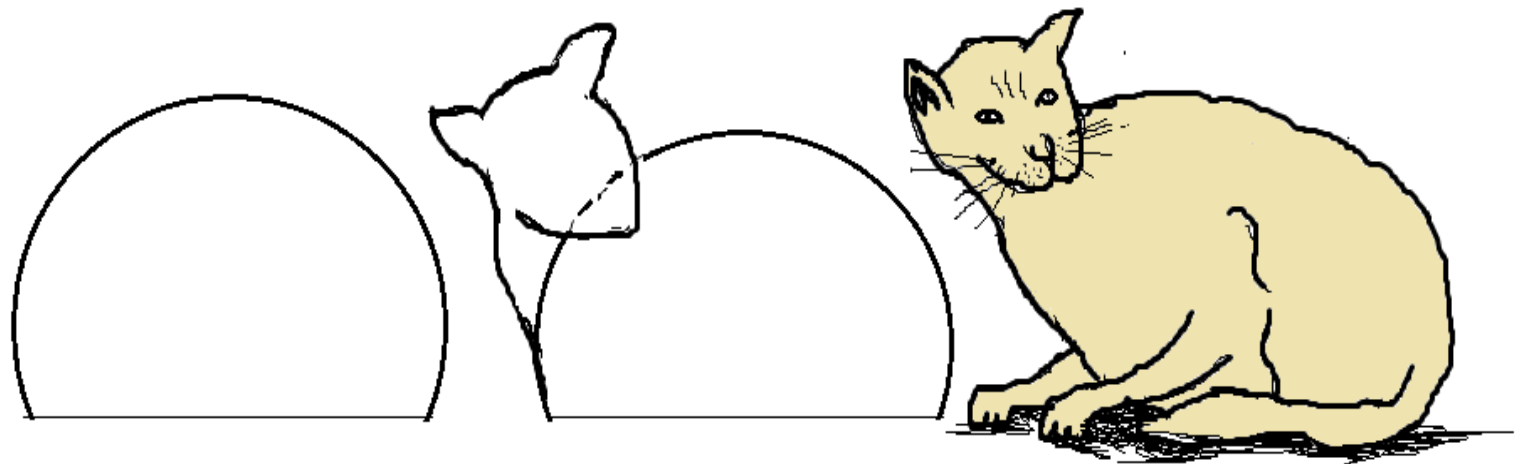

# Les arbres

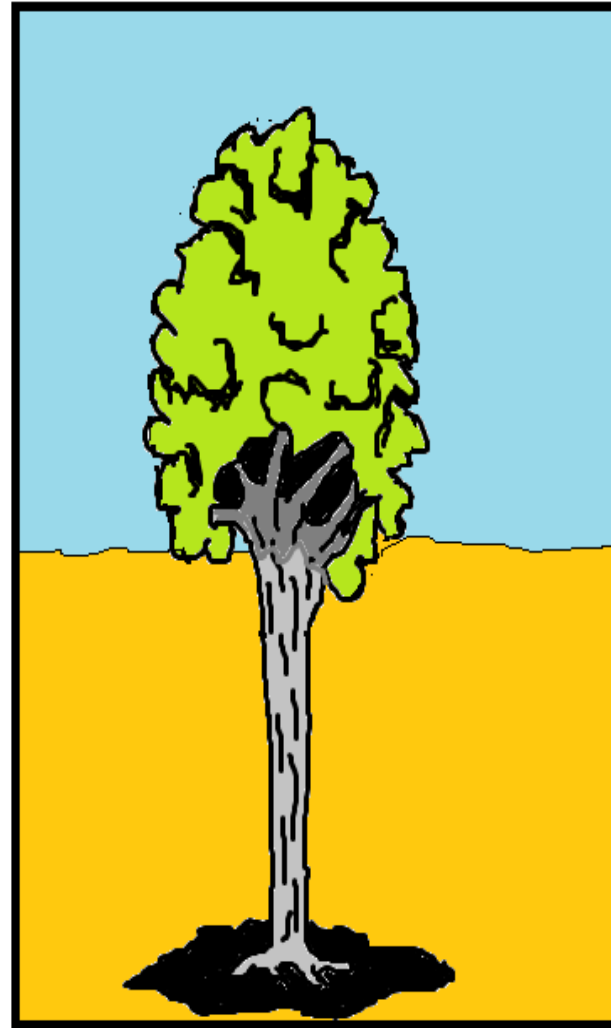
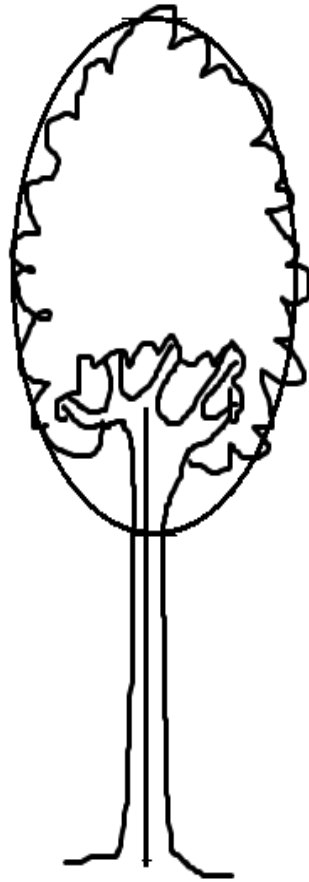
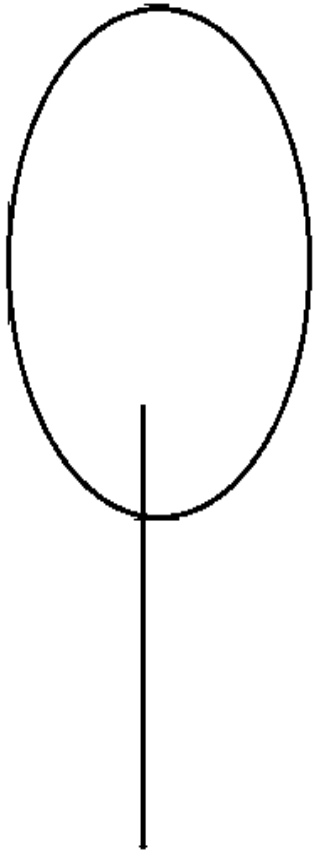

# Les arbres

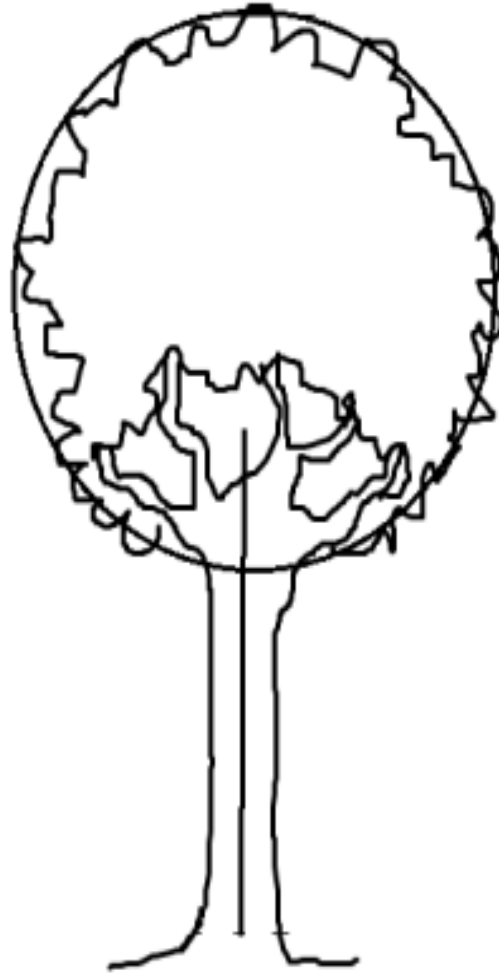
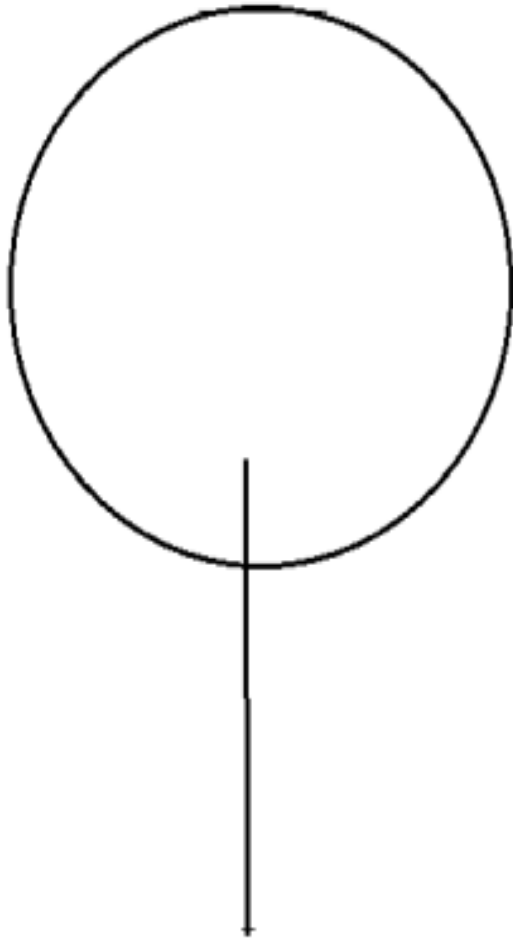

# Le cocotier

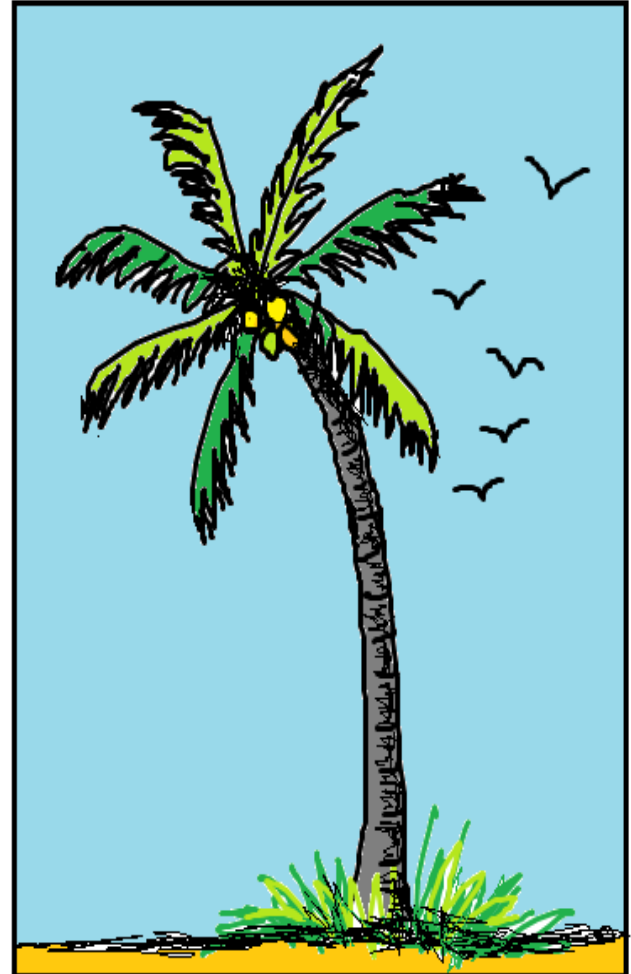
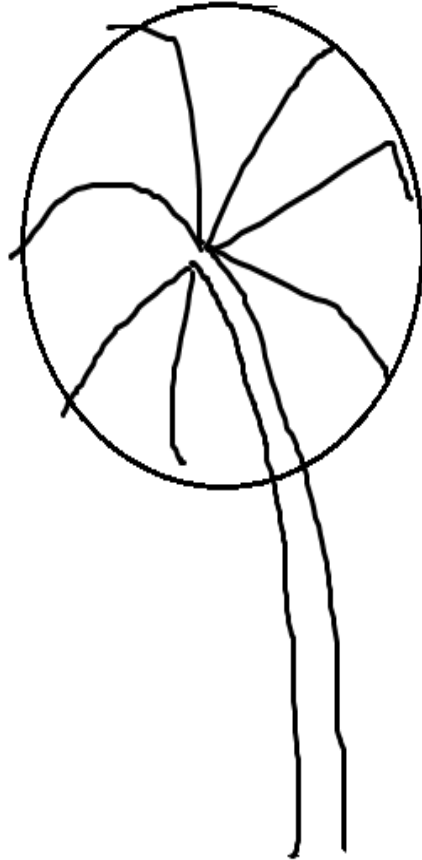
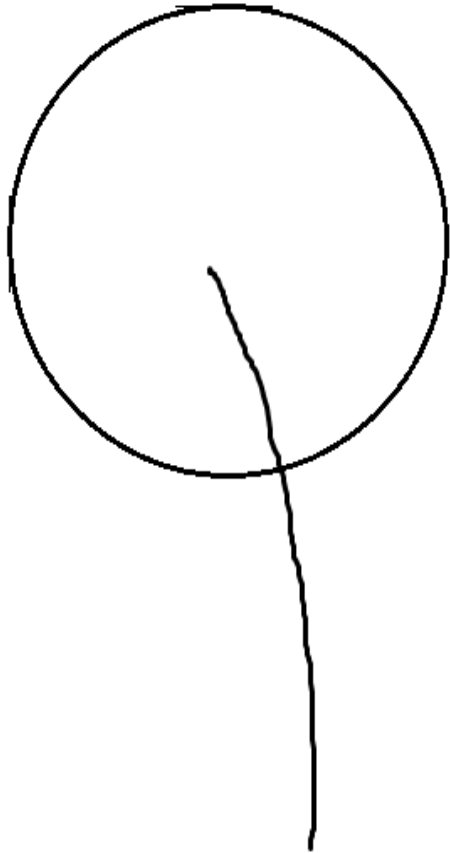

# Autres techniques

## Le canard

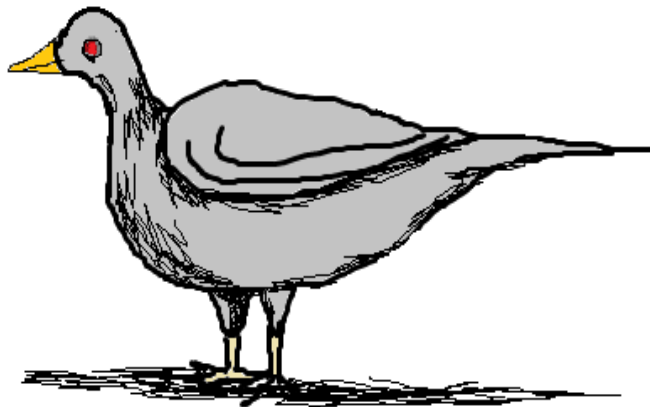

# Le bébé assis de face sur une natte

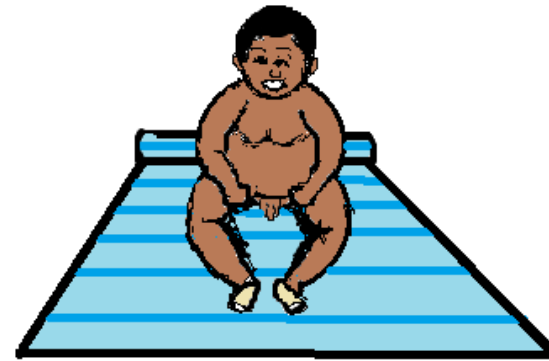

# La souris vue de profil gauche

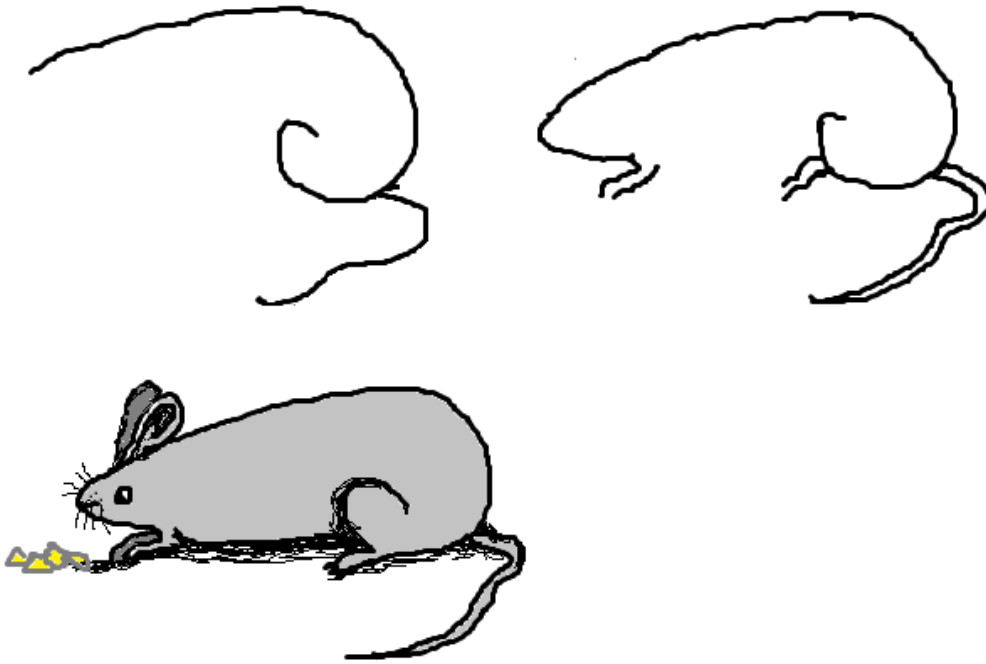

# La femme vue de face

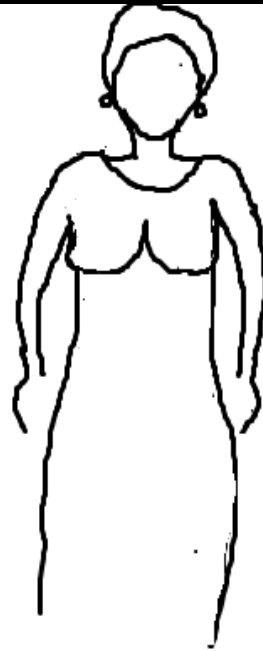
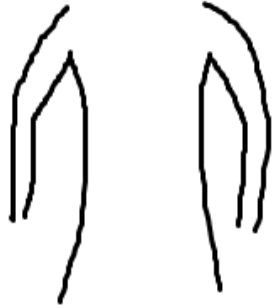

# La technique du dessin d'un personnage humain

## Le croquis par la charpente osseuse et ses proportions

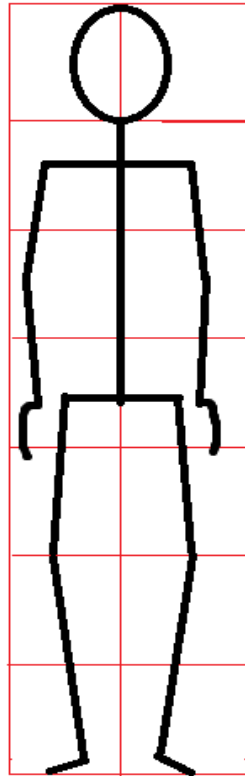

# La technique du dessin d'un personnage humain

Le redressement- L'arrangement- La finition

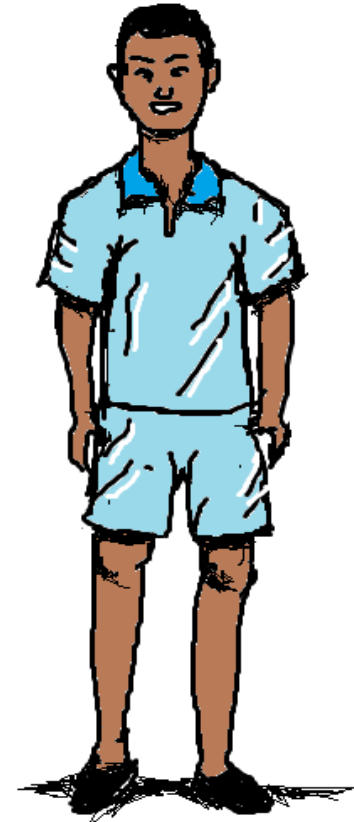
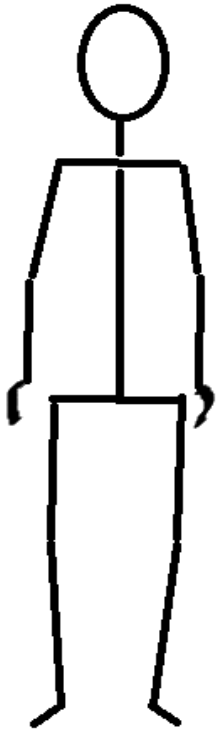

# La technique du dessin d'un personnage humain

Le croquis-Le redressement-L'arrangement- La finition

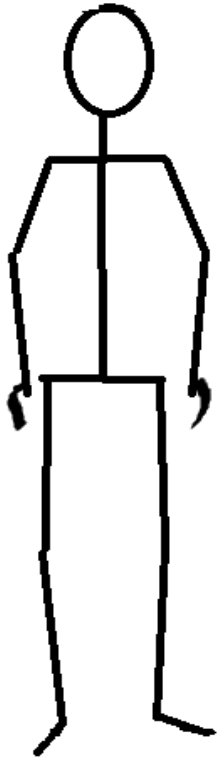

# La tête et ses proportions

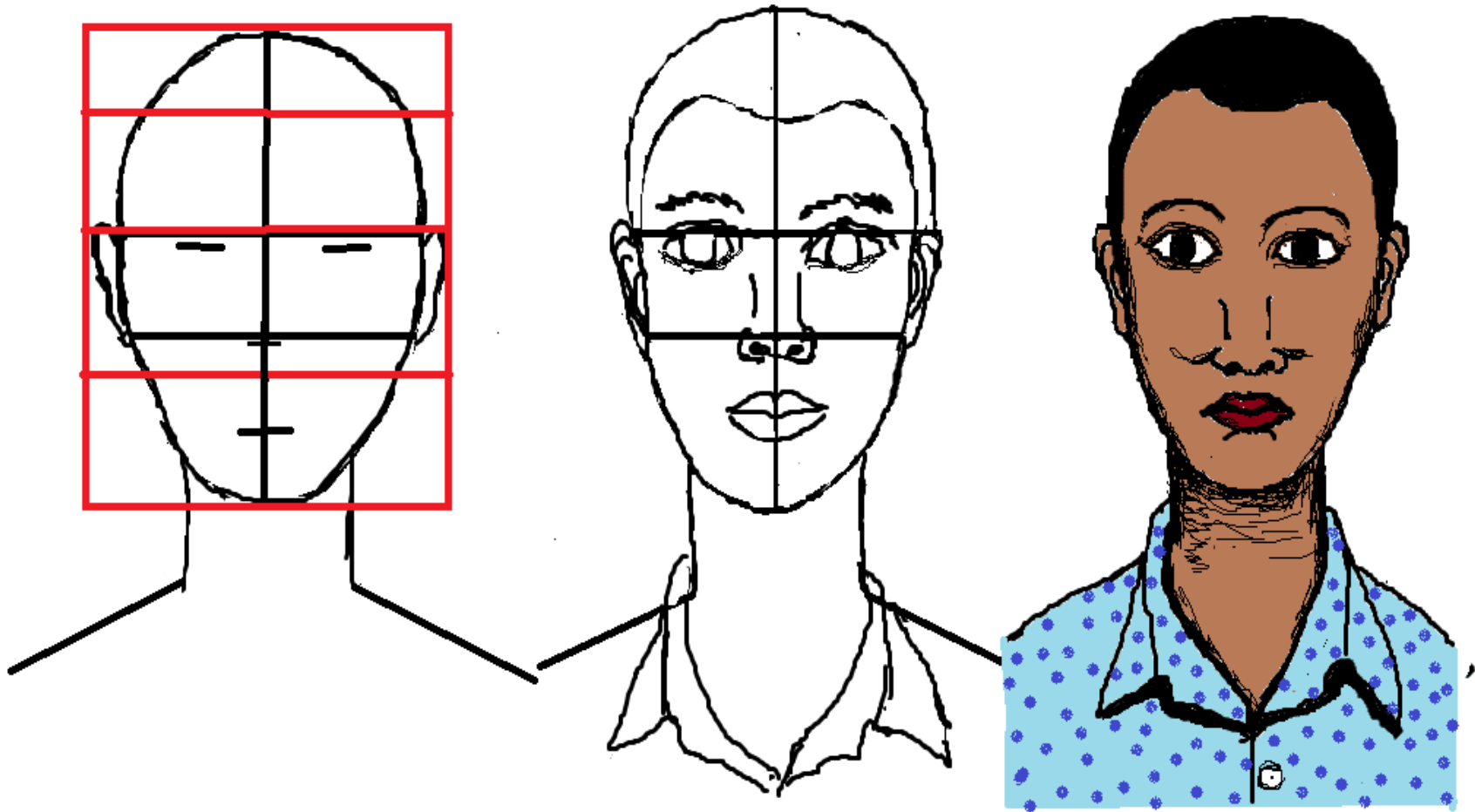

# La tête et ses proportions

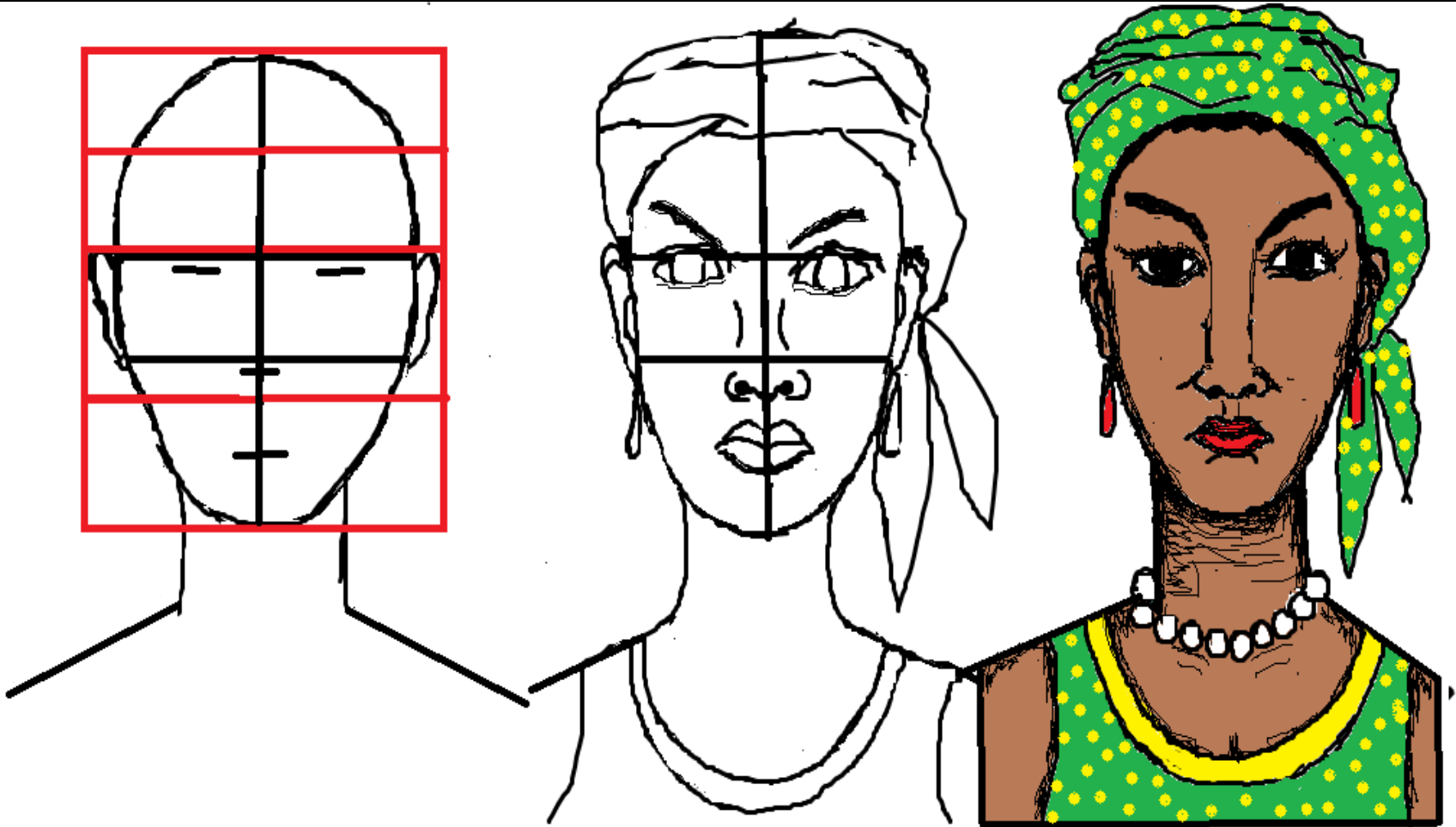

# Les mouvements de la tête

Sens du mouvement de la tête

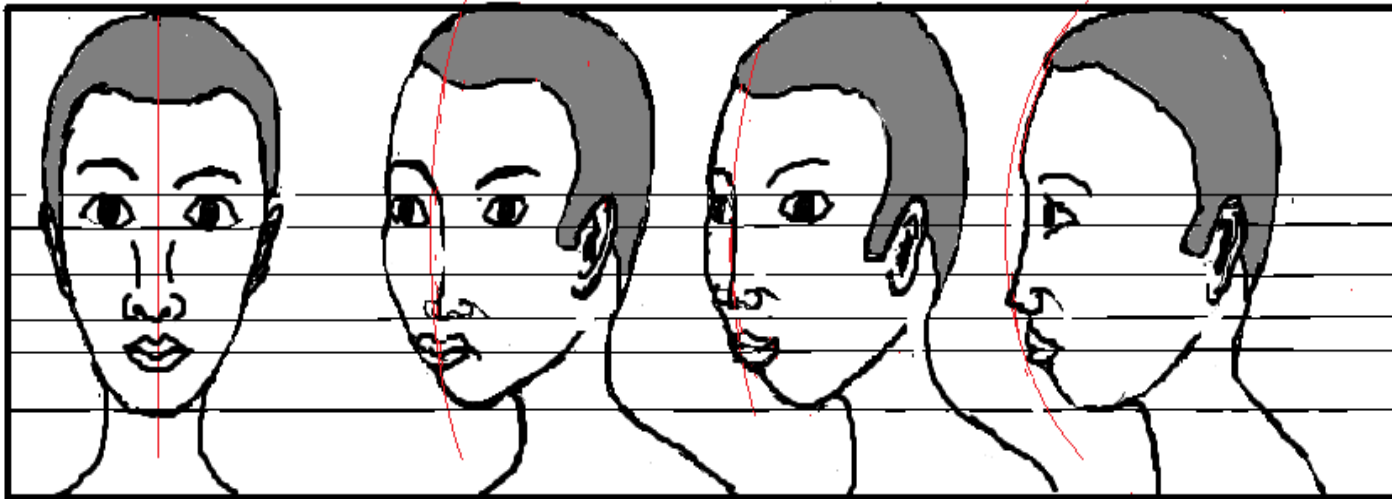

Visage de face

Visage au 3/4

Visage au 3/4

Visage au profil

# Le mouvement du corps

## *Scène de labour*



# Le mouvement du corps

## *Scène culinaire*



# Le mouvement du corps

## Le coucher

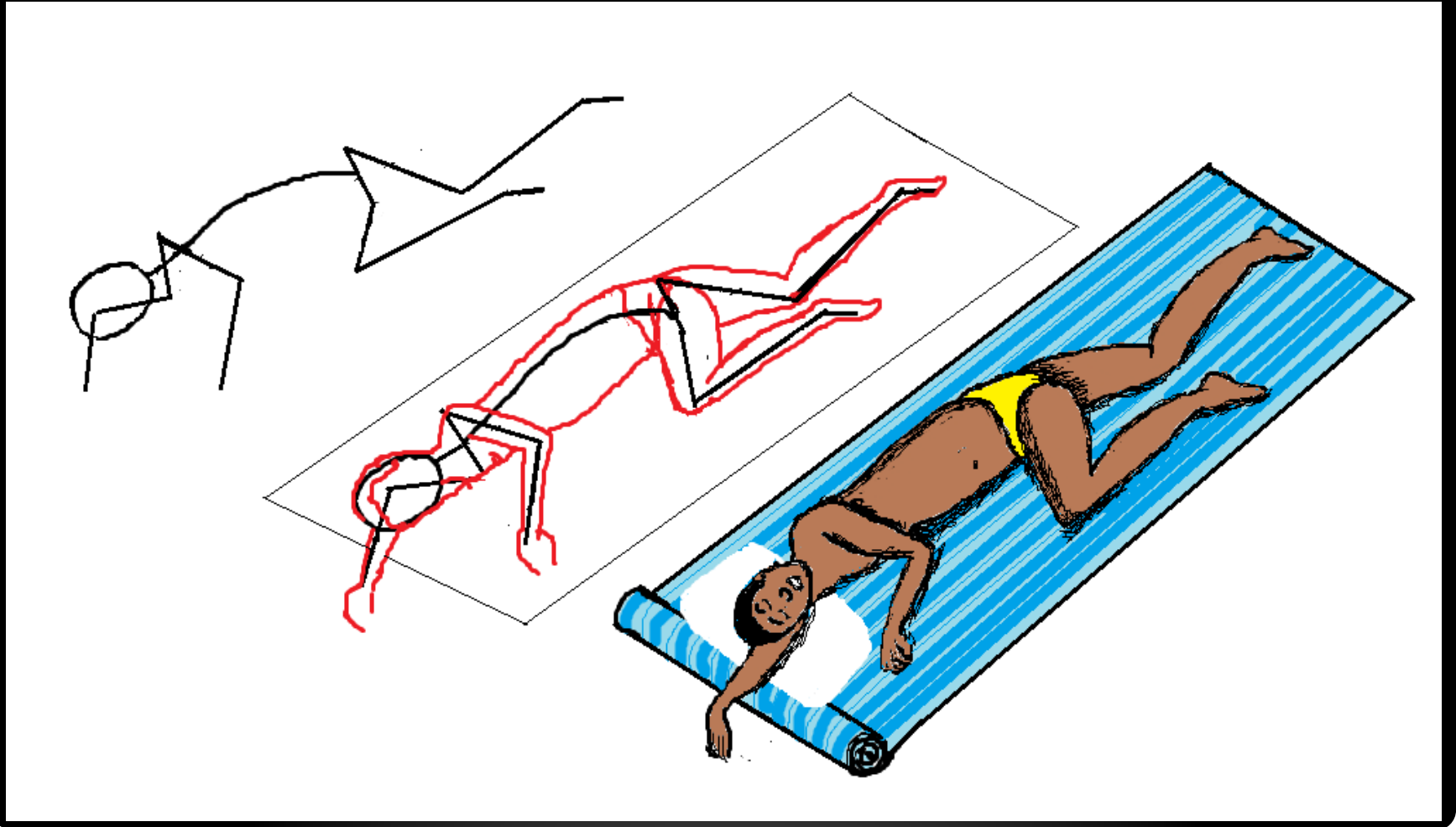

# Le mouvement du corps

## *Croquis : Scène de marché*

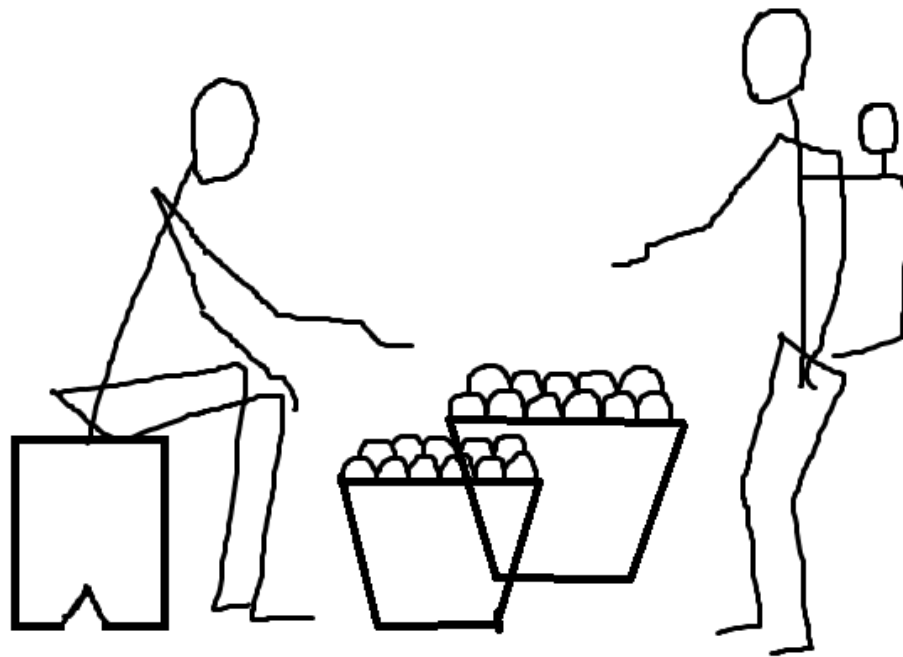

# Le mouvement du corps

## *Redressement et Arrangement*



# Le mouvement du corps

## La Finition



# Quelques exemples de composition Nature morte ou composition d'objets



# Nature morte

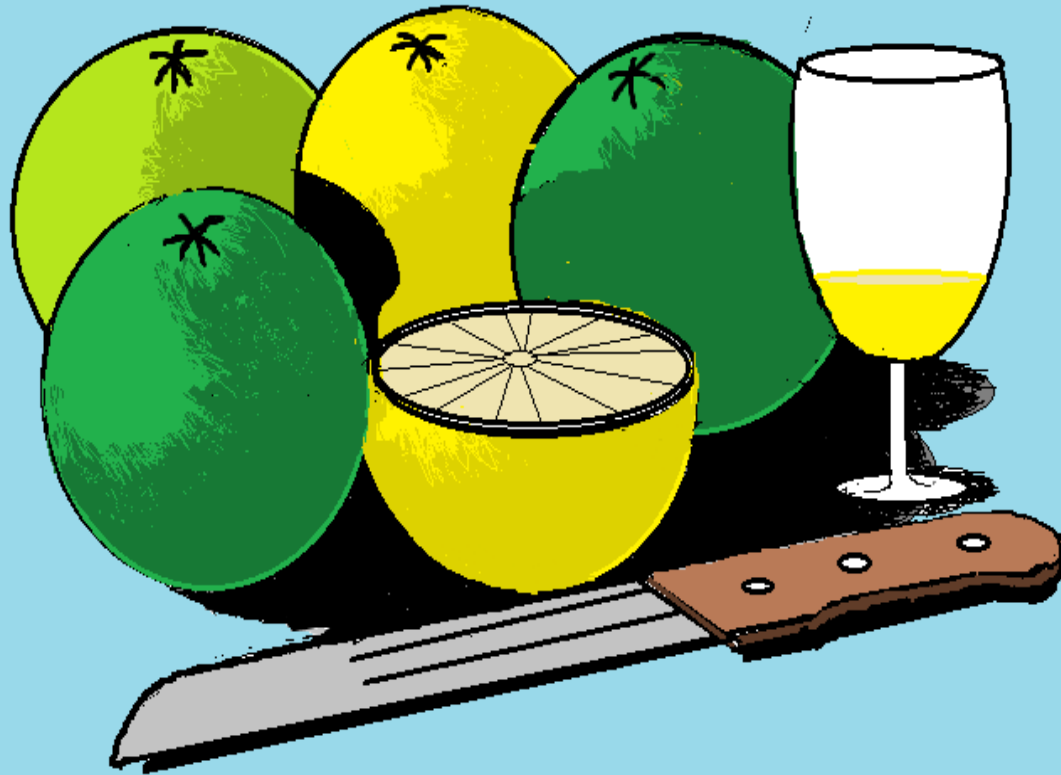

# Nature morte



# Nature morte ou composition d'objets

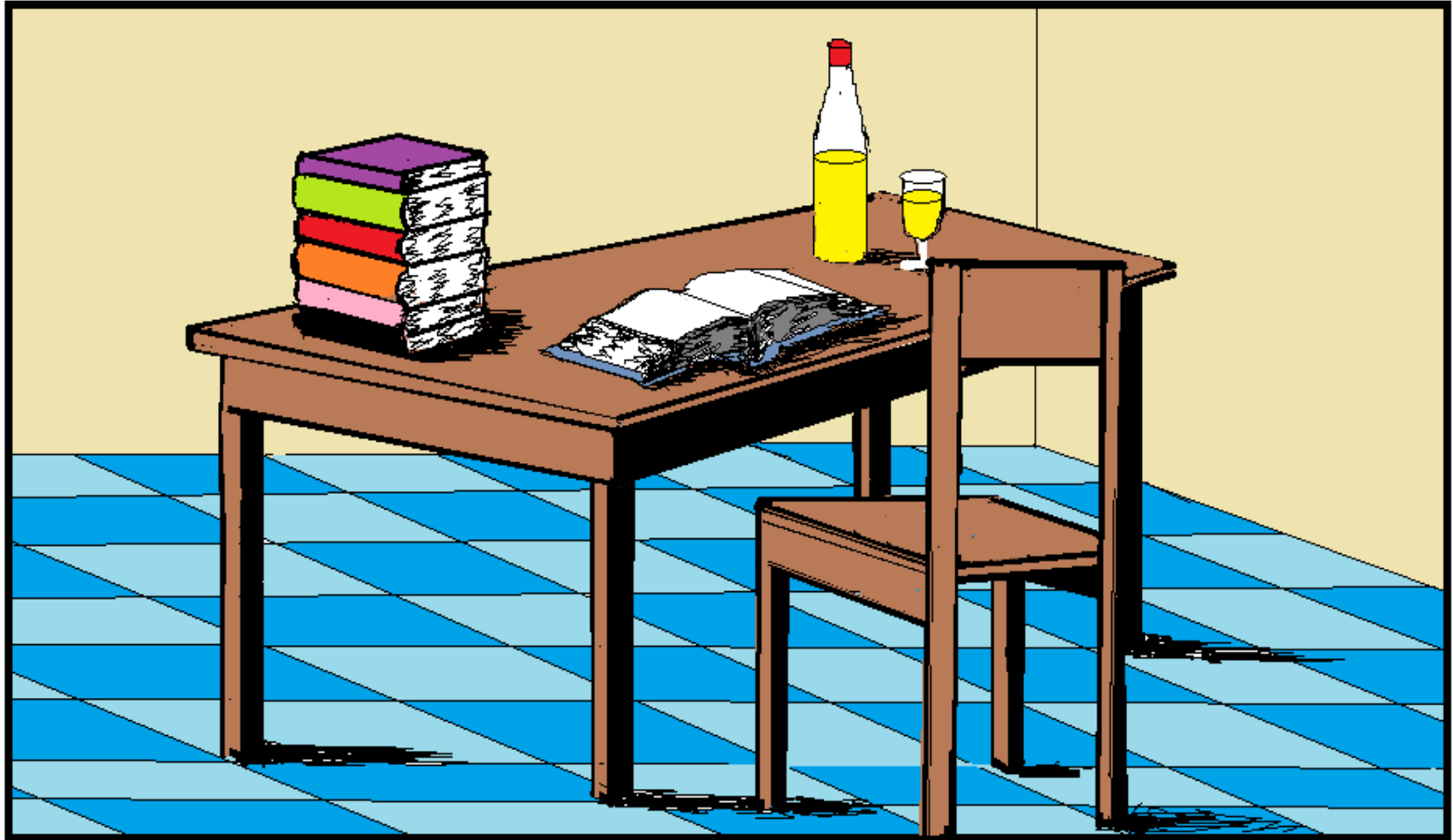

# Nature morte ou composition d'objets

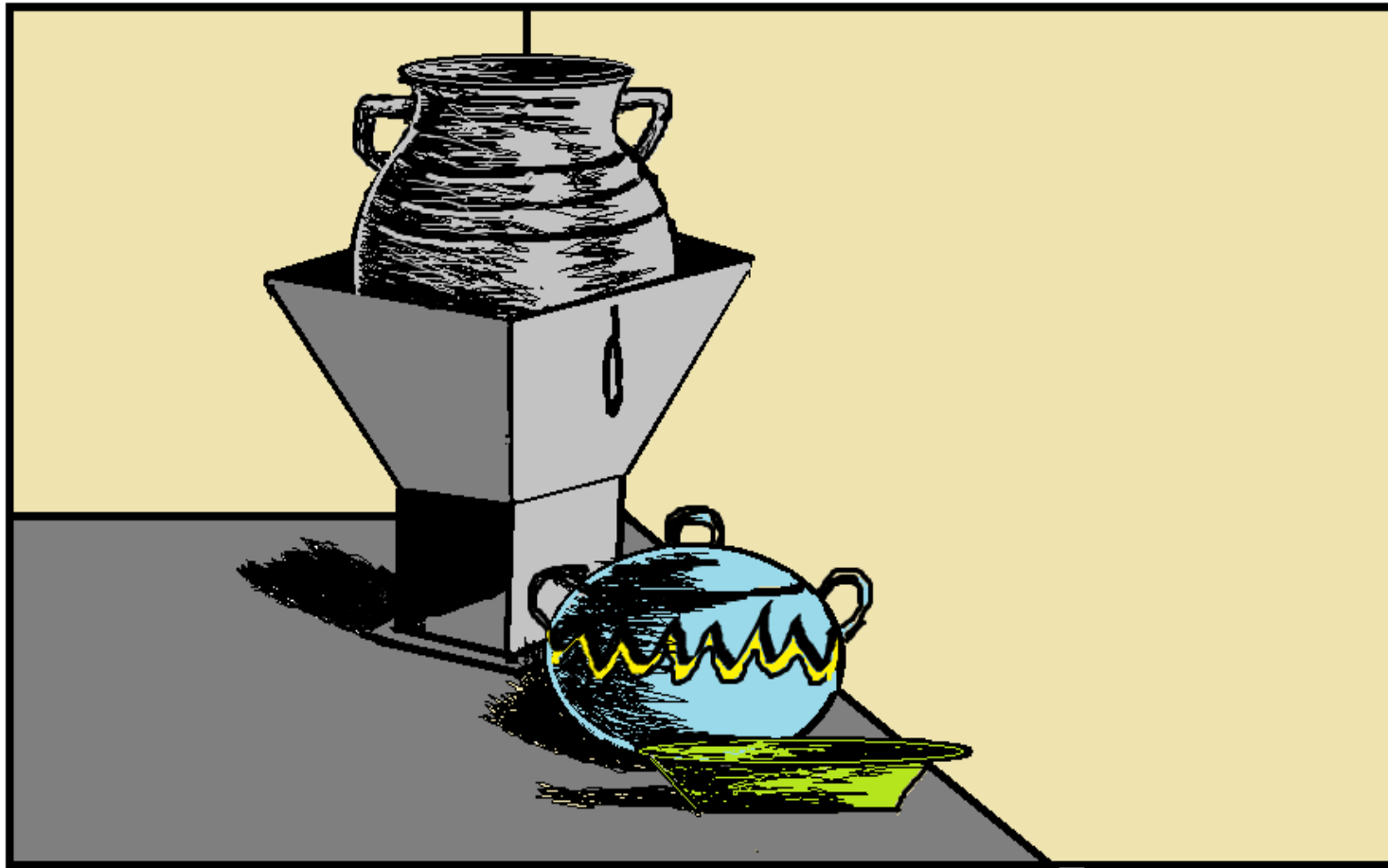

# Paysage



# Paysage

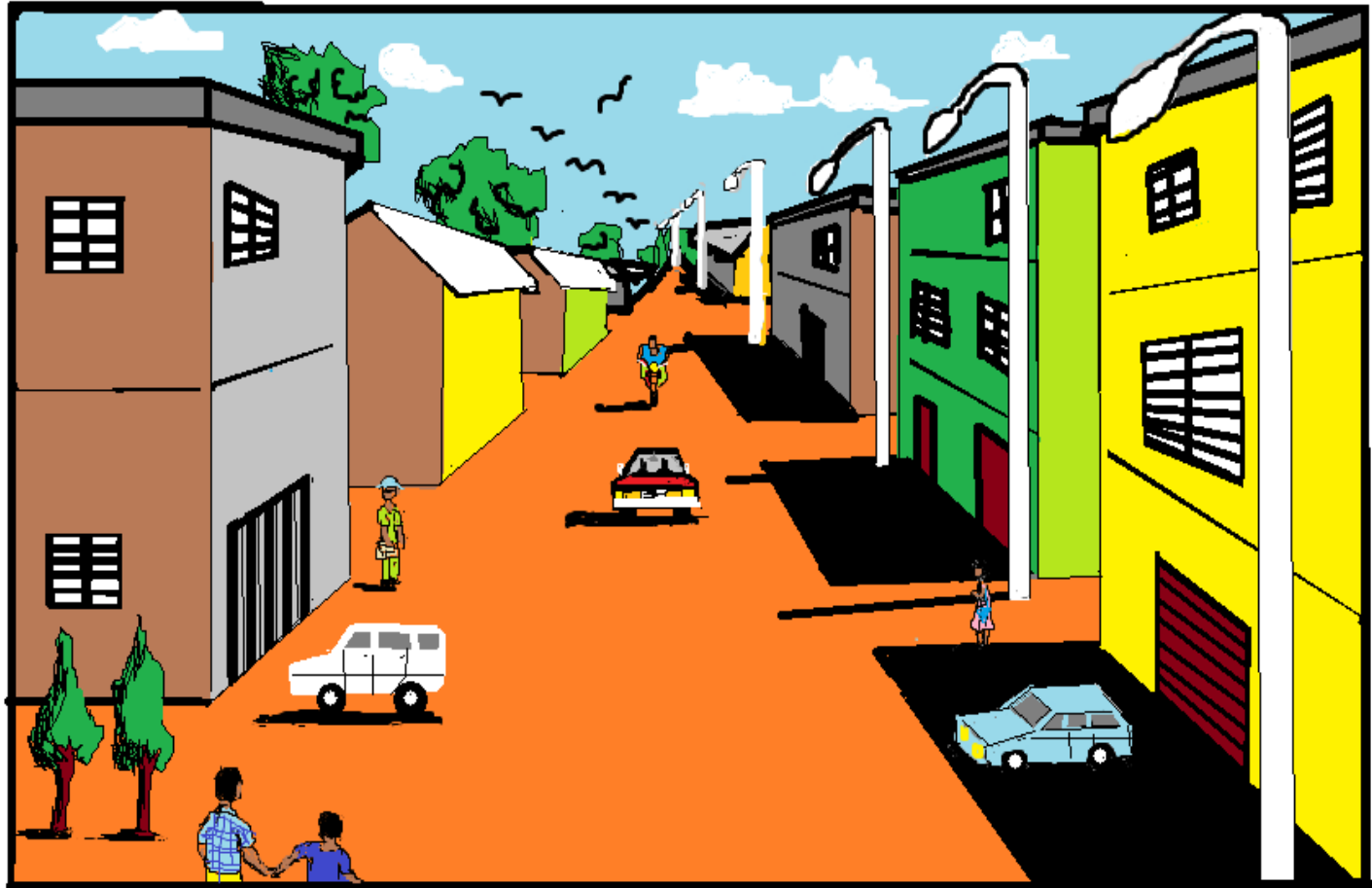

# Paysage



JE  
VOUS REMERCIE